



AG PRICE LIST

Effective May 4th, 2026



2026

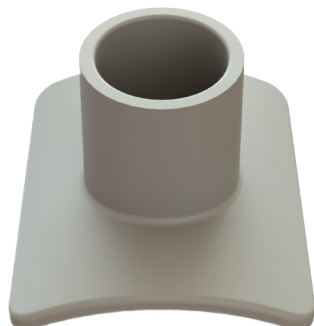
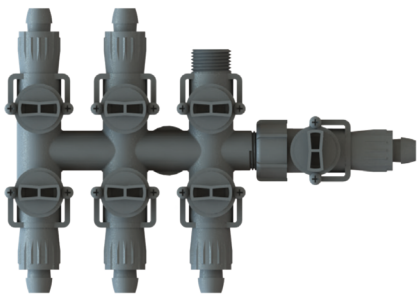

“Glue-N-Go” Manifolds

D1

- 8** • BVT-007 FHT / MHT
 • RPMHT#B
 • RPLMHT#B
 • RPCAP 75
 • RFC#
 • RV#

- 9** • RVL#SW
 • RPT#SW
 • RPT#SOC
 • RV#-T
 • RVEL#
 • RVEL#-T

- 10** • RVT#
 • RVT#-W/FHT
 • RVTT#
 • RVTL#
 • RVTT#-MHT

- 11** • RV4#-C
 • RV4#-V
 • RV4#-C-W/FHT
 • RV6#-C
 • RV6#-V
 • RV6#-C-W/FHT

- 12** • RSIV4#
 • RSIV4#-L
 • RSI4#-LV
 • RVS16#
 • RT2#-1WAY
 • RT4#

- 13** • RSI2#-1WAY
 • RSI2#-1WAYMHT
 • RSI4#
 • RSI4#-L
 • RSI4#-LV
 • RYFHT-#

- 14 Combination Assembly**
 • RVTT8-MHT / RSI46

- 15 Flushing Manifolds**
 • RY#
 • RF#
 • RVFT-#
 • RE-0##

- 16 Repair Kits**
 • RVRK#
 • RVRK-TEE-#
 • RVRK-ELL-#
 • RVRC
 • RVRK-BV with -BR

Ball Valves

D3

- 17** • PVC Ball Valves

Automatic Irrigation Control

D4

- 18** • Logic Plus S - 2 Wire Controller

Valves

D3

- 19** • 500 Series Straight Flow Valves

Low Flow Irrigation

D3

- 20** • Hydro-Pro Adjustable Jets
 • Micro-Sprinklers
 • Dial - A - Pro Emitters

- 21** • Omni-Pro Flow Controllers
 • ISO-Pro Emitters
 • PC-Pro Emitters

- 22** • Super-Pro Emitters
 • Inline-Pro Emitters
 • Aqua-Pro Emitters
 • Mini-Pro Inline
 • Misti-Pro Misters

- 23** • Micro-Pro Micro Sprinklers
 • Stato-Pro Jets
 • Roto-Pro Mini Sprinklers

- 24** • Hydro-Pro Jets
 • Rain Pro Risers

- 25** • Pro Riser Assemblies
 • Micro-Pro Fittings

- 26** • Solvent Weld Pro Adapters
 • Pro Compression Couplings

- 27** • Pro Compression Elbows
 • Pro Compression Tees
 • Pro Compression End Plugs
 • Pro ¾" Swivel Adapters

- 28** • Pro ¾" Swivel Tees
 • Pro ¾" Male Hose Adapters
 • Pro Insert Fittings
 • Pro Swing Riser Fittings

- 29** • Pro ½" Riser Adapters
 • Blank Ended Riser Adapters
 • Hole Punch
 • Pro Plastic Stakes

- 30** • Pro Automatic Flush Valves
 • Pro Valves
 • Miscellaneous
 • Pro Pressure Regulators

Accessories

- 31** • Pipe Saddles
32 • Grooved Coupling
 • Pressure Gauges

D1

D1

Sand Media Filters

D1

- 33** • 12" Sand Media Technical
34 • 24" Sand Media Technical
35 • Sand media Pricing
37 • Self Cleaning Gravity Screen Filter

Dual Stage Lake / Pump Filter

D3

- 38** • PON-00#
39 • RainPro Hand Pump

T-FILTER

By Hit Products

**NEW
PRODUCT**

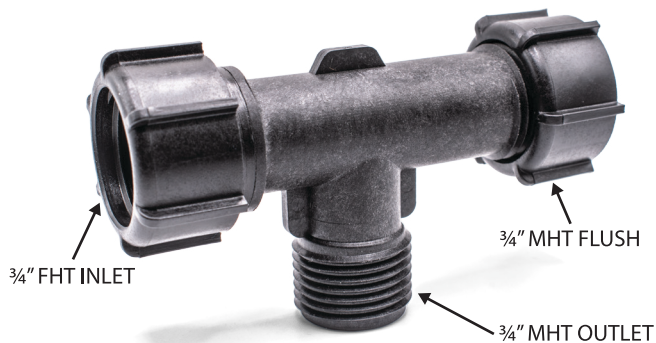

STANDARD 3/4" HOSE THREAD "T" FILTER

EXTRA LONG 3/4" HOSE THREAD "T" FILTER (50% LONGER THAN STANDARD FILTER)

PART

- RF007S-50 -WITH 50 MESH SCREEN YELLOW
- RF007S-100 -WITH 100 MESH SCREEN BLUE
- RF007S-150 -WITH 150 MESH SCREEN BLACK
- RF007S-200 -WITH 200 MESH SCREEN RED

LIST PRICE \$7.73

- RF007S - (BODY ONLY)

LIST PRICE \$2.97

PART

- RF007L-50 -WITH 50 MESH SCREEN YELLOW
- RF007L-100 -WITH 100 MESH SCREEN BLUE
- RF007L-150 -WITH 150 MESH SCREEN BLACK
- RF007L-200 -WITH 200 MESH SCREEN RED

LIST PRICE \$8.92

- RF007L - (BODY ONLY)

LIST PRICE \$3.57

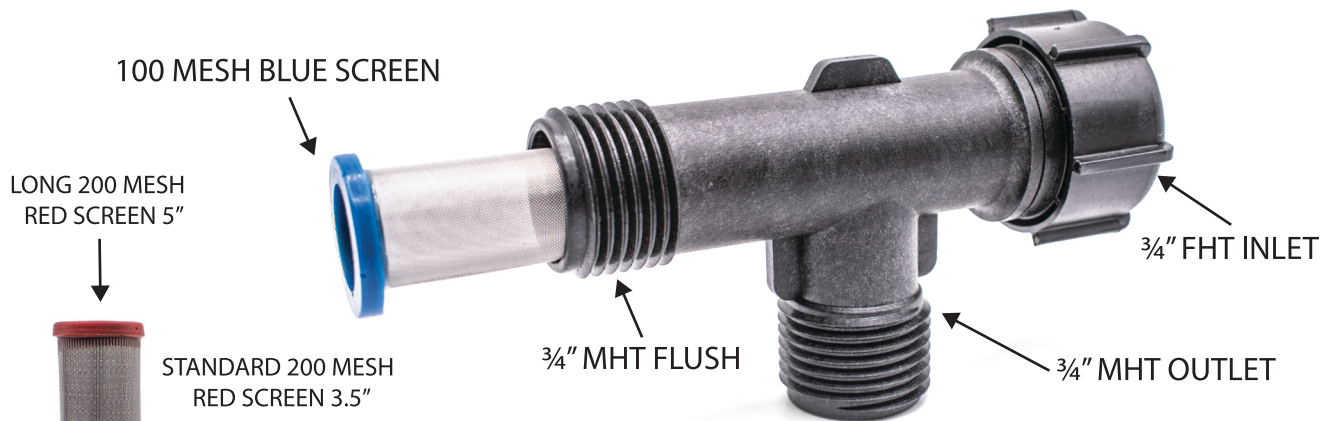

SCREEN ONLY OPTIONS

- 50 MESH SCREEN YELLOW
- 100 MESH SCREEN BLUE
- 150 MESH SCREEN BLACK
- 200 MESH SCREEN RED

SHORT SCREEN ONLY PART

- 1850-50S
- 1850-100S
- 1850-150S
- 1850-200S

LIST PRICE \$4.76

LONG SCREEN ONLY PART

- 1850-50L
- 1850-100L
- 1850-150L
- 1850-200L

LIST PRICE \$5.35



"Glue-N-Go" Manifolds

BENEFITS OF USING MANIFOLDS

- Manifolds are pre-assembled requiring No Field Assembly
- Total control of each individual output
- High Flow Valve with low pressure loss = energy savings
- Easy replacement with Repair Coupling
- Reduced Labor Cost

MANIFOLD FEATURES

- One complete manifold of 6, 4, 2 or 1 outlet
- Dedicated High Flow Ball Valve per outlet
- High Flow Ball Valves are field service-able
- Manifold Inlet is a 3/4" Socket / 1" Spigot
- Easy start-up flush without contamination
- Low Profile Installation
- Low Profile Handles
- Deep Socket Inlet Repair Coupler

6 Outlet with Optional Ball Valve for Flushing

Outlet Choices:

- 500 ID / 16mm
- 550 ID / 17mm
- 600 ID / 18mm
- 700 ID / 20mm
- 800 ID / 3/4"
- 3/4" Male Hose Thread Outlet

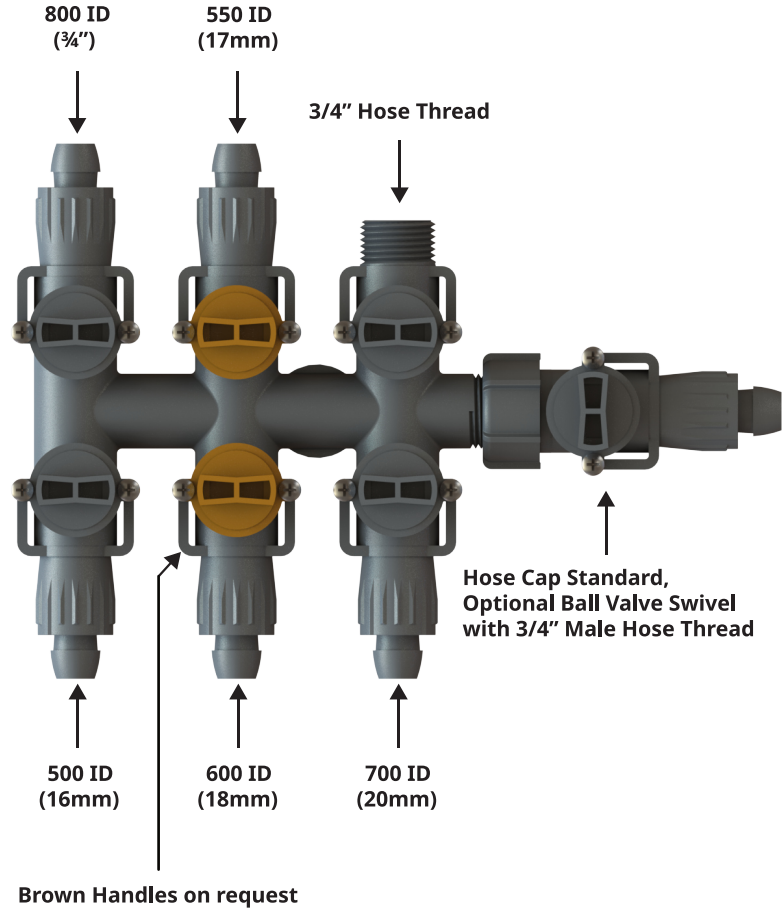

Hose Cap Standard, Optional Ball Valve Swivel with 3/4" Male Hose Thread

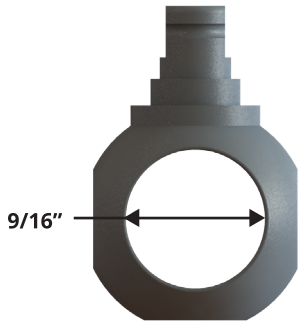

High Flow Ball Valve



Deep Socket Inlet Repair Coupler

1" Socket x 3/4" Socket / 1" Spigot

3/4" Deep Socket Inlet with 3/4" x 1" Spigot Repair Coupler (Does Not Lose Hose Height)

Riser in the Field

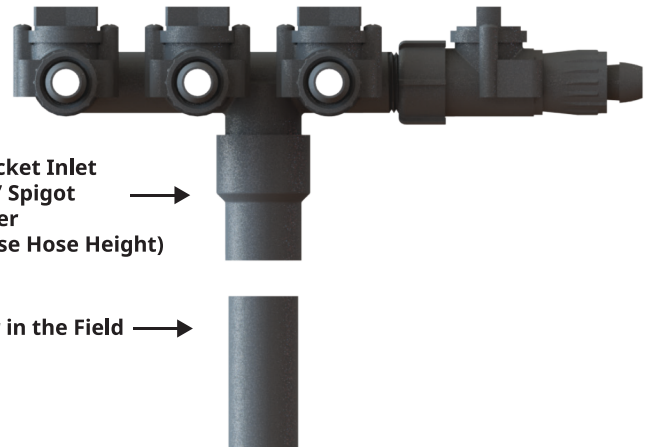

MIP Valve



OPERATING SPECIFICATIONS

- High Flow Valve
- Female Hose Thread Swivel
- Male Hose Thread

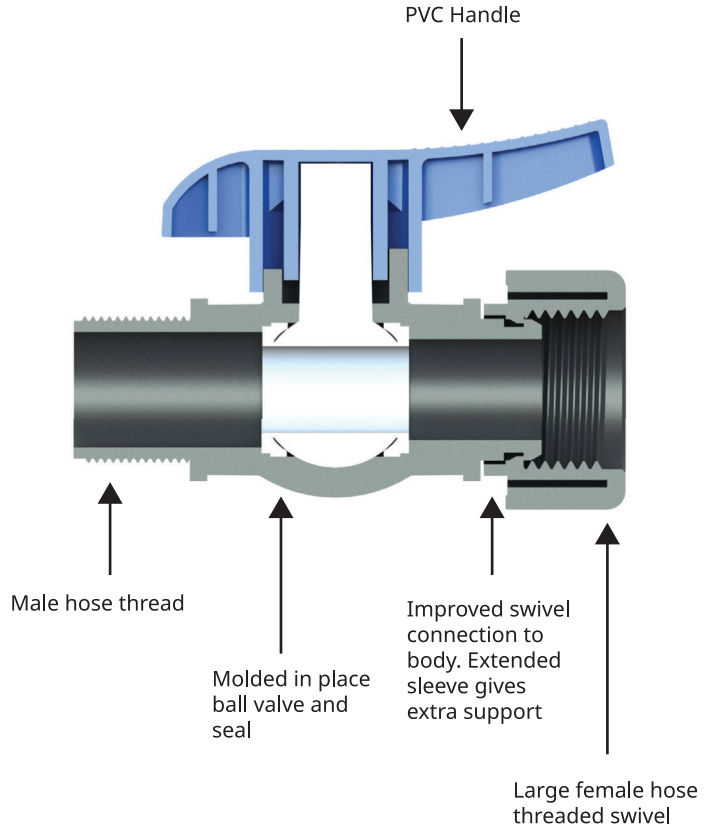

Manifold Options

Slip Inlet

1) 1" Slip inlet in lieu of standard 3/4" slip inlet.
(suffix part # with a "-1")
List Price: \$1.10

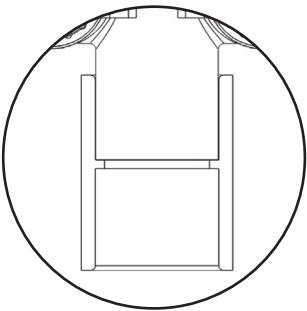

Female Hose Thread

2) Female Hose Thread (FHT) Swivel inlet in lieu of standard 3/4" slip inlet.
(suffix part # with a "-W/FHT")
List Price: \$2.33

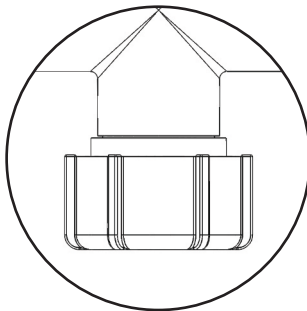

Swivel with Washer Screen

3) Female Hose Thread (FHT) Swivel with Washer Screen on inlet in lieu of standard 3/4" slip inlet.
(suffix part # with a "-W/FHT-S")
List Price: \$2.58

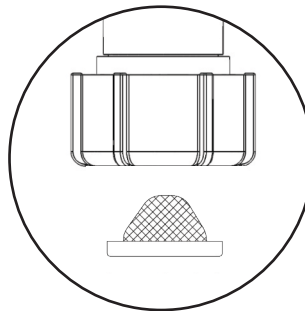

Flush Valve

4) Flush Valve in place of a cap.
(suffix part # with a "-V")

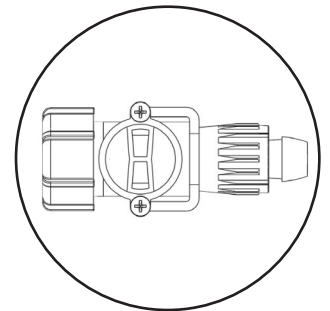

Manifold Combination Examples

Manifolds outlets and sections can be customized to your needs.

1
RV6656-C

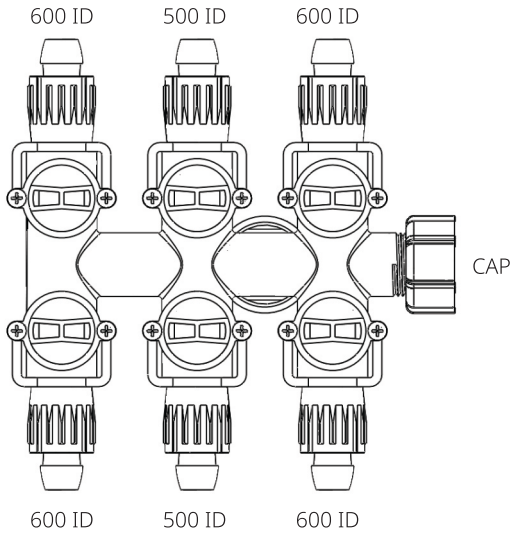

2
RV478-C

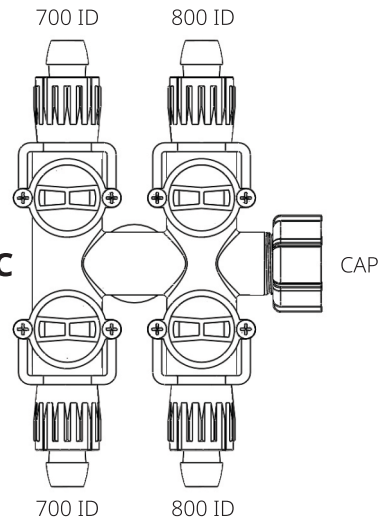

3
RV6686-V-1

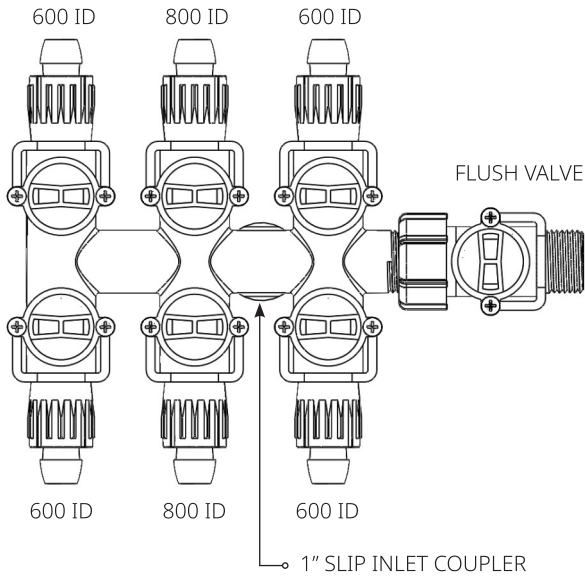

4
RYFHT-5

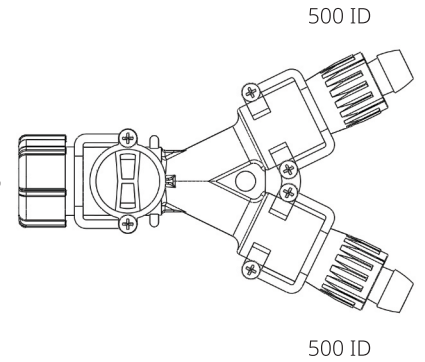

5
RVTT5-MHT + RSI47
(Pre Assembled)

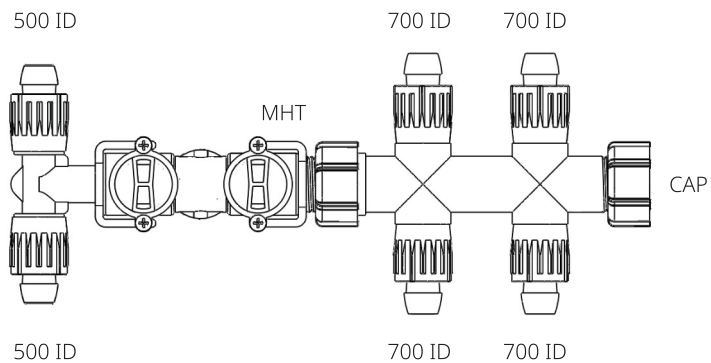

How to Order Riser Manifolds

These examples do not represent all possible combinations

1. Choose Item

Item Type	Page 6 Example	Part # Example
RV = Riser Valve	1, 2, 3, 5	RV 6656-C
RY = WYE Configuration	4	RY FHT-5
RSI = Side Inlet	5	RSI 48
RF = Straight Flushing Valve		RF 5

2. Choose Outlets

Outlet Type	Page 6 Example	Part # Example
T = Has 2 outlets	5	RV IT 5-MHT
4 = Has 4 outlets	2	RV 4 78-C
6 = Has 6 outlets	1, 3	RV 6 656-C

3. Choose Size Configuration

Size Configuration Type	Page 6 Example	Part # Example
656 = First 2 outlets are 600id, Second 2 outlets are 700id, and Third 2 outlets are 600id	1	RV6 676 -C
686 = First 2 outlets are 600id, Second 2 outlets are 800id, and Third 2 outlets are 600id	3	RV6 686 -V-1
78 = First 2 outlets are 700id and second 2 outlets are 800id.	2	RV4 78 -C
7 = All 4 outlets are 700id		RV4 7
5 = Both outlets are 500id		RVT 5

4. Choose End Item

End Item	Page 6 Example	Part # Example
C = Cap	1, 2, 5	RV6656- C
V = Flush Valve	3	RV6686- V
MHT = Male Hose Thread		RVTT5- MHT
FHT = Female Hose Thread		RVTT5- FHT

Note: Numerous configurations are available.
Please reference page 5 for other manifold options.

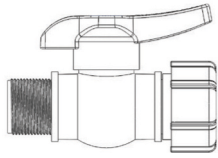

MIP VALVE

HIGH FLOW MIP VALVE

Part #	Series	List Price	Bag Qty	Box Qty
BVT-007 FHT/MHT	¾" FHT SWIVEL x ¾" MHT	\$3.07	25	200

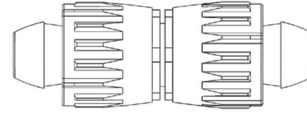

COUPLER

STRAIGHT BARB LOC COUPLER

Part #	Intlet / Outlet	List Price	Bag Qty	Box Qty
RFC5	500 BARB	\$0.79	25	500
RFC55	550 BARB	\$0.88	25	500
RFC6	600 BARB	\$0.81	25	500
RFC7	700 BARB	\$1.11	25	400
RFC8	800 BARB	\$2.27	25	300

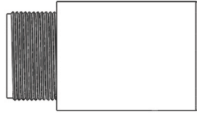

ADAPTER - STRAIGHT

SOCKET ADAPTER

Part #	Series	List Price	Bag Qty	Box Qty
RPMHT5B	¾" MHT x ½" SOCKET	\$0.79	25	600
RPMHT7B	¾" MHT x ¾" SOCKET	\$0.91	25	400
RPMHT10B	¾" MHT x 1" SOCKET	\$1.21	25	300

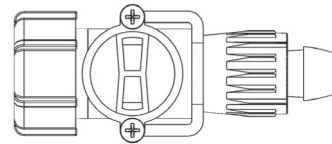

STRAIGHT - BALL VALVE

BALL VALVE WITH ¾" FHT SWIVEL INLET
AND BARB OUTLET OR ¾" MHT OUTLET

Part #	Outlet	List Price
RVMHT	3/4" MHT	\$4.60
RV5	500 BARB	\$4.91
RV55	550 BARB	\$4.91
RV6	600 BARB	\$4.91
RV7	700 BARB	\$4.91
RV8	800 BARB	\$4.91

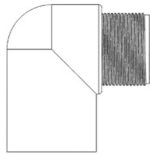

ADAPTER- ELBOW

SOCKET ADAPTER 90° ELBOW

Part #	Series	List Price	Bag Qty	Box Qty
RPLMHT5B	¾" MHT x ½" SOCKET	\$1.77	25	500
RPLMHT7B	¾" MHT x ¾" SOCKET	\$1.96	25	400

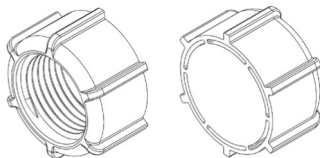

END CAP

¾" FHT END CAP WITH WASHER

Part #	Description	List Price	Bag Qty	Box Qty
RPCAP 75	¾" FHT CAP	\$0.77	25	500

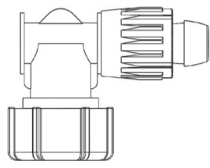

ELBOW - SWIVEL

3/4" SWIVEL INLET WITH BARB OUTLET OR 3/4" MHT OUTLET

Part #	Outlet	List Price	Bag Qty	Box Qty
RVLMHTSW	3/4" MHT	\$1.69	25	250
RVL5SW	500 BARB	\$1.69	25	200
RVL55SW	550 BARB	\$1.69	25	200
RVL6SW	600 BARB	\$1.69	25	200
RVL7SW	700 BARB	\$1.84	25	200
RVL8SW	800 BARB	\$2.21	25	175

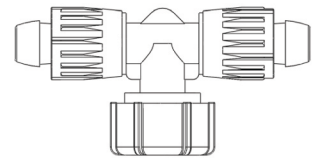
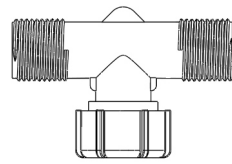

TEE - SWIVEL

3/4" SWIVEL INLET WITH BARB OUTLET OR 3/4" MHT OUTLET

Part #	Outlet	List Price	Bag Qty	Box Qty
RPTMHTSW	3/4" MHT	\$2.03	25	250
RPT5SW	500 BARB	\$3.00	25	250
RPT55SW	550 BARB	\$3.44	25	250
RPT6SW	600 BARB	\$3.05	25	250
RPT7SW	700 BARB	\$3.45	25	250
RPT8SW	800 BARB	\$6.93	25	175

ADD: -S FOR SCREEN WASHER \$.37

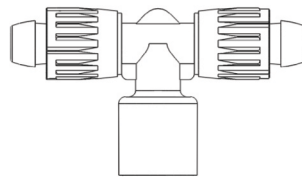
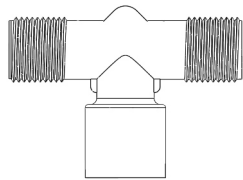

TEE - SOC/SPIGOT

3/4" SOC / 1" SPIGOT WITH BARB OUTLET OR 3/4" MHT OUTLET

Part #	Outlet	List Price	Bag Qty	Box Qty
RPTMHTSOC	3/4" MHT	\$2.16	25	250
RPT5SOC	500 BARB	\$2.41	25	200
RPT55SOC	550 BARB	\$2.78	25	200
RPT6SOC	600 BARB	\$2.41	25	200
RPT7SOC	700 BARB	\$2.49	25	200
RPT8SOC	800 BARB	\$5.86	25	175

ADD: -S FOR SCREEN WASHER \$.37

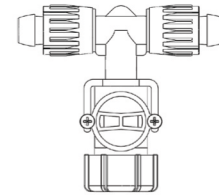

TEE - BALL VALVE

TEE BALL VALVE WITH 3/4" FHT SWIVEL INLET AND BARB OUTLET

Part #	Outlet	List Price
RV5-T	500 BARB	\$8.59
RV55-T	550 BARB	\$8.59
RV6-T	600 BARB	\$8.59
RV7-T	700 BARB	\$8.59
RV8-T	800 BARB	\$8.59

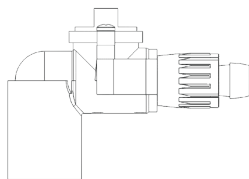

ELBOW - BALL VALVE - SOC/SPIG

ELBOW BALL VALVE WITH 3/4" SOC / 1" SPIGOT INLET AND BARB OUTLET OR 3/4" MHT OUTLET

Part #	Outlet	List Price
RVELMHT	3/4" MHT	\$4.60
RVEL5	500 BARB	\$5.70
RVEL55	550 BARB	\$5.70
RVEL6	600 BARB	\$5.70
RVEL7	700 BARB	\$5.70
RVEL8	800 BARB	\$5.70

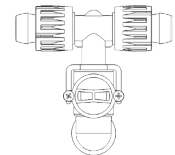
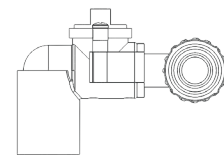

ELBOW TEE - BALL VALVE - SOC/SPIG

ELBOW BALL VALVE WITH 3/4" SOC / 1" SPIGOT INLET AND TEE BARB OUTLET

Part #	Outlet	List Price
RVEL5-T	500 BARB	\$8.59
RVEL55-T	550 BARB	\$8.59
RVEL6-T	600 BARB	\$8.59
RVEL7-T	700 BARB	\$8.59
RVEL8-T	800 BARB	\$8.59

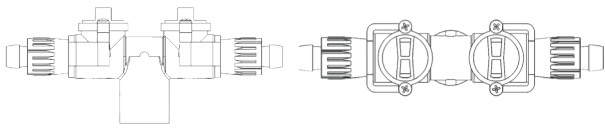

TEE - BALL VALVES - SOC/SPIG

TEE BALL VALVE WITH 3/4" SOC / 1" SPIGOT INLET AND TEE BARB OUTLET OR 3/4" MHT OUTLET

Part #	Outlet	List Price
RVTMHT	3/4" MHT	\$7.91
RVT5	500 BARB	\$8.46
RVT55	550 BARB	\$8.46
RVT6	600 BARB	\$8.46
RVT7	700 BARB	\$8.46
RVT8	800 BARB	\$8.46

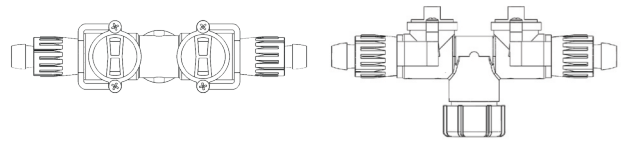

TEE - BALL VALVES - SWIVEL

TEE BALL VALVE WITH 3/4" SFHT SWIVEL INLET AND TEE BARB OUTLET OR 3/4" MHT OUTLET

Part #	Outlet	List Price
RVTMHT-W/FHT	3/4" MHT	\$10.24
RVT5-W/FHT	500 BARB	\$10.79
RVT55-W/FHT	550 BARB	\$10.79
RVT6-W/FHT	600 BARB	\$10.79
RVT7-W/FHT	700 BARB	\$10.79
RVT8-W/FHT	800 BARB	\$10.79

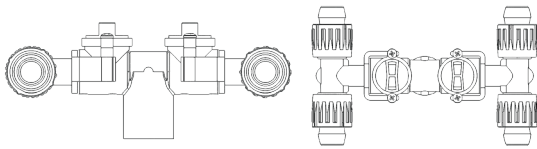

TEE - BALL VALVES - SOC/SPIG

TEE BALL VALVES WITH 3/4" SOC / 1" SPIGOT INLET AND TEE BARB OUTLET

Part #	Outlet	List Price
RVTT5	500 BARB	\$16.68
RVTT55	550 BARB	\$16.68
RVTT6	600 BARB	\$16.68
RVTT7	700 BARB	\$16.68
RVTT8	800 BARB	\$16.68

ADD: -W/FHT FOR FHT SWIVEL INLET \$18.46

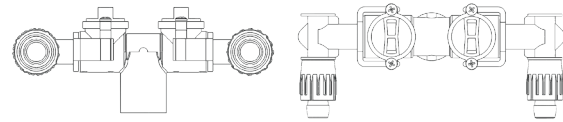

ELL - BALL VALVES - SOC/SPIG

TEE BALL VALVE WITH 3/4" SOC / 1" SPIGOT INLET AND ELBOW BARB OUTLET OR ELBOW 3/4" MHT OUTLET

Part #	Outlet	List Price
RVTL5	500 BARB	\$16.13
RVTL55	550 BARB	\$16.13
RVTL6	600 BARB	\$16.13
RVTL7	700 BARB	\$16.13
RVTL8	800 BARB	\$16.13

ADD: -W/FHT FOR FHT SWIVEL INLET \$18.46

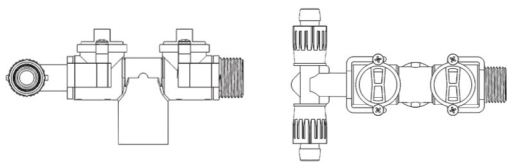

TEE - BALL VALVES - SOC/SPIG

TEE BALL VALVE WITH 3/4" SOC / 1" SPIGOT INLET AND TEE BARB OUTLET + 3/4" MHT OUTLET

Part #	Outlet	List Price
RVTT5-MHT	500 BARB	\$16.13
RVTT55-MHT	550 BARB	\$16.13
RVTT6-MHT	600 BARB	\$16.13
RVTT7-MHT	700 BARB	\$16.13
RVTT8-MHT	800 BARB	\$16.13

ADD: -W/FHT FOR FHT SWIVEL INLET \$18.46

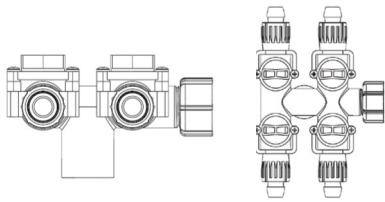

4 OUTLET - BALL VALVES - SOC/SPIG

BALL VALVES WITH 3/4" SOC / 1" SPIGOT INLET
AND 4 BARB OUTLETS OR 3/4" MHT OUTLETS + FLUSH CAP

Part #	Outlet	List Price
RV4MHT-C	3/4" MHT	\$17.78
RV45-C	500 BARB	\$19.01
RV455-C	550 BARB	\$19.01
RV46-C	600 BARB	\$19.01
RV47-C	700 BARB	\$19.01
RV48-C	800 BARB	\$19.01

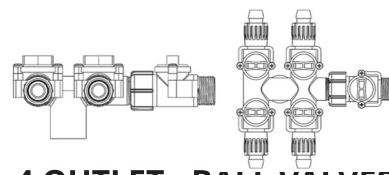

4 OUTLET - BALL VALVES - SOC/SPIG

BALL VALVES WITH 3/4" SOC / 1" SPIGOT INLET
AND 4 BARB OUTLETS OR 3/4" MHT OUTLETS + FLUSH VALVE

Part #	Outlet	List Price
RV4MHT-V	3/4" MHT	\$20.72
RV45-V	500 BARB	\$22.02
RV455-V	550 BARB	\$22.02
RV46-V	600 BARB	\$22.02
RV47-V	700 BARB	\$22.02
RV48-V	800 BARB	\$22.02

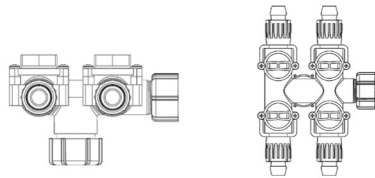

4 OUTLET - BALL VALVES - SWIVEL

BALL VALVES WITH 3/4" FHT SWIVEL INLET
AND 4 BARB OUTLETS OR 3/4" MHT OUTLETS + FLUSH CAP

Part #	Outlet	List Price
RV4MHT-C-W/FHT	3/4" MHT	\$20.12
RV45-C-W/FHT	500 BARB	\$21.34
RV455-C-W/FHT	550 BARB	\$21.34
RV46-C-W/FHT	600 BARB	\$21.34
RV47-C-W/FHT	700 BARB	\$21.34
RV48-C-W/FHT	800 BARB	\$21.34

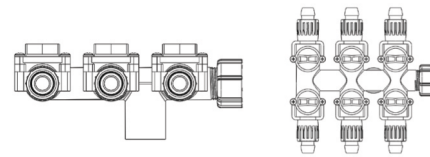

6 OUTLET - BALL VALVES - SOC/SPIG

BALL VALVES WITH 3/4" SOC / 1" SPIGOT INLET
AND 6 BARB OUTLETS OR 3/4" MHT OUTLETS + FLUSH CAP

Part #	Outlet	List Price
RV6MHT-C	3/4" MHT	\$24.41
RV65-C	500 BARB	\$25.70
RV655-C	550 BARB	\$25.70
RV66-C	600 BARB	\$25.70
RV67-C	700 BARB	\$25.70
RV68-C	800 BARB	\$25.70

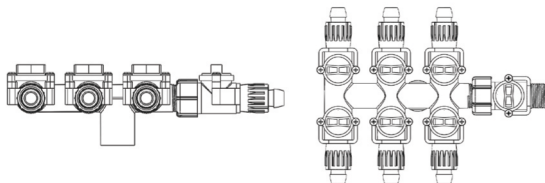

6 OUTLET - BALL VALVES - SOC/SPIG

BALL VALVES WITH 3/4" SOC / 1" SPIGOT INLET
AND 6 BARB OUTLETS OR 3/4" MHT OUTLETS + FLUSH VALVE

Part #	Outlet	List Price
RV6MHT-V	3/4" MHT	\$27.54
RV65-V	500 BARB	\$28.82
RV655-V	550 BARB	\$28.82
RV66-V	600 BARB	\$28.82
RV67-V	700 BARB	\$28.82
RV68-V	800 BARB	\$28.82

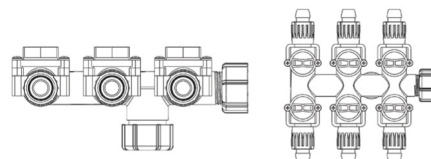

6 OUTLET - BALL VALVES - SWIVEL

BALL VALVES WITH 3/4" FHT SWIVEL INLET
AND 6 BARB OUTLETS OR 3/4" MHT OUTLETS + FLUSH CAP

Part #	Outlet	List Price
RV6MHT-C-W/FHT	3/4" MHT	\$26.74
RV65-C-W/FHT	500 BARB	\$28.02
RV655-C-W/FHT	550 BARB	\$28.02
RV66-C-W/FHT	600 BARB	\$28.02
RV67-C-W/FHT	700 BARB	\$28.02
RV68-C-W/FHT	800 BARB	\$28.02

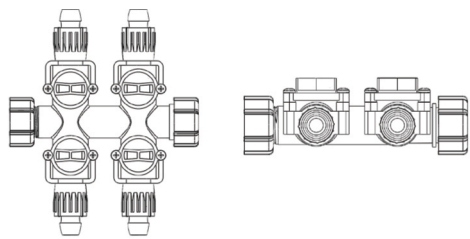

4 OUTLET - SIDE INLET SWIVEL - BALL VALVES

3/4" FHT INLET SWIVEL AND 4 BALL VALVE BARB OUTLETS
OR 3/4" MHT OUTLETS + FLUSH CAP

Part #	Outlet	List Price
RSIV4MHT	3/4" MHT	\$19.62
RSIV45	500 BARB	\$20.72
RSIV455	550 BARB	\$20.72
RSIV46	600 BARB	\$20.72
RSIV47	700 BARB	\$20.72
RSIV48	800 BARB	\$20.72

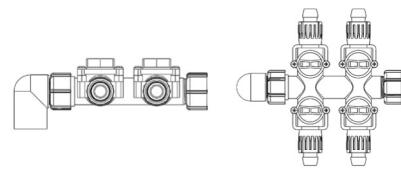

4 OUTLET - ELBOW - BALL VALVES

ELBOW ADAPTER WITH RSIV4 MANIFOLD
(4 BALL VALVE BARB OUTLETS OR 3/4" MHT OUTLETS + FLUSH CAP)

Part #	Outlet	List Price
RSIV4MHT-L	3/4" MHT	\$20.60
RSIV45-L	500 BARB	\$21.96
RSIV455-L	550 BARB	\$21.96
RSIV46-L	600 BARB	\$21.96
RSIV47-L	700 BARB	\$21.96
RSIV48-L	800 BARB	\$21.96

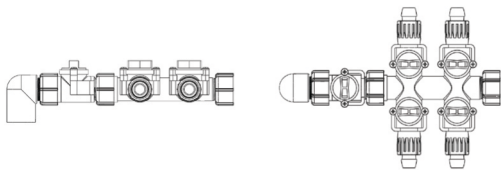

4 OUTLET - ELBOW - BALL VALVES

ELBOW ADAPTER WITH RV + RSIV4 MANIFOLD
(4 BARB OUTLETS OR 3/4" MHT OUTLETS + FLUSH CAP)

Part #	Outlet	List Price
RSIV4MHT-LV	3/4" MHT	\$25.75
RSIV45-LV	500 BARB	\$27.10
RSIV455-LV	550 BARB	\$27.10
RSIV46-LV	600 BARB	\$27.10
RSIV47-LV	700 BARB	\$27.10
RSIV48-LV	800 BARB	\$27.10

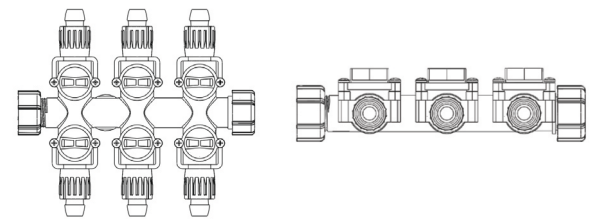

6 OUTLET - SIDE INLET SWIVEL - BALL VALVES

3/4" FHT INLET SWIVEL AND 6 BALL VALVE BARB OUTLETS
OR 3/4" MHT OUTLETS + FLUSH CAP

Part #	Outlet	List Price
RVSI6MHT	3/4" MHT	\$22.77
RVSI65	500 BARB	\$23.80
RVSI655	550 BARB	\$23.80
RVSI66	600 BARB	\$23.80
RVSI67	700 BARB	\$23.80
RVSI68	800 BARB	\$23.80

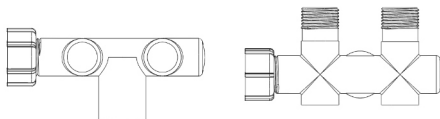

2 OUTLET - SOC/SPIG - 1 WAY

3/4" SOC / 1" SPIGOT INLET AND 2 BARB OUTLETS
OR 3/4" MHT OUTLETS + FLUSH CAP

Part #	Outlet	List Price
RT2MHT-1WAY	3/4" MHT	\$6.57
RT25-1WAY	500 BARB	\$7.35
RT255-1WAY	550 BARB	\$7.35
RT26-1WAY	600 BARB	\$7.35
RT27-1WAY	700 BARB	\$7.35
RT28-1WAY	800 BARB	\$7.35

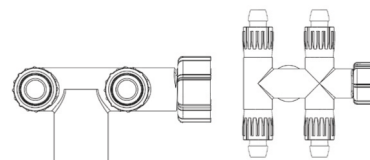

4 OUTLET - SOC/SPIG

3/4" SOC / 1" SPIGOT INLET
AND 4 BARB OUTLETS OR 3/4" MHT OUTLETS + FLUSH CAP

Part #	Outlet	List Price
RT4MHT	3/4" MHT	\$6.75
RT45	500 BARB	\$7.91
RT455	550 BARB	\$7.91
RT46	600 BARB	\$7.91
RT47	700 BARB	\$7.91
RT48	800 BARB	\$7.91

ADD: -W/FHT FOR FHT SWIVEL INLET \$10.24

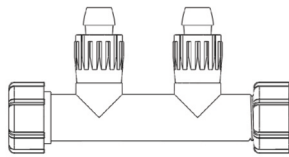

2 OUTLET - STRAIGHT - SWIVEL - 1 WAY

3/4" FHT INLET SWIVEL AND 2 BARB OUTLETS
OR 3/4" MHT OUTLETS + FLUSH CAP

Part #	Outlet	List Price
RSI2MHT-1WAY	3/4" MHT	\$7.35
RSI25-1WAY	500 BARB	\$7.97
RSI255-1WAY	550 BARB	\$7.97
RSI26-1WAY	600 BARB	\$7.97
RSI27-1WAY	700 BARB	\$7.97
RSI28-1WAY	800 BARB	\$7.97

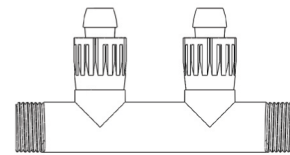

2 OUTLET - STRAIGHT - SWIVEL - 1 WAY

3/4" MHT/MHT INLET
AND 2 BARB OUTLETS

Part #	Outlet	List Price
RSI26-1WAYMHT	600 BARB	\$7.38
RSI27-1WAYMHT	700 BARB	\$7.38

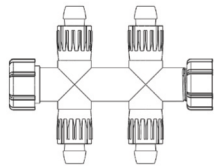

4 OUTLET - SIDE INLET SWIVEL

3/4" FHT INLET AND 4 BARB OUTLETS
OR 3/4" MHT OUTLETS + FLUSH CAP

Part #	Outlet	List Price
RSI4MHT	3/4" MHT	\$7.42
RSI45	500 BARB	\$8.46
RSI455	550 BARB	\$8.46
RSI46	600 BARB	\$8.46
RSI47	700 BARB	\$8.46
RSI48	800 BARB	\$8.46

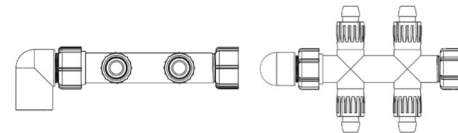

4 OUTLET - ELBOW

ELBOW ADAPTER WITH RSI4 MANIFOLD
(4 BARB OUTLETS OR 3/4" MHT OUTLETS + FLUSH CAP)

Part #	Outlet	List Price
RSI4MHT-L	3/4" MHT	\$8.40
RSI45-L	500 BARB	\$9.44
RSI455-L	550 BARB	\$9.44
RSI46-L	600 BARB	\$9.44
RSI47-L	700 BARB	\$9.44
RSI48-L	800 BARB	\$9.44

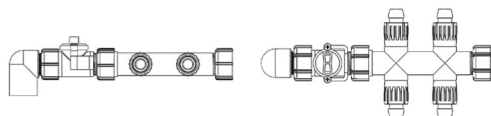

4 OUTLET - ELBOW - BALL VALVE

ELBOW ADAPTER WITH RV + RSI4 MANIFOLD
(4 BARB OUTLETS OR 3/4" MHT OUTLETS + FLUSH CAP)

Part #	Outlet	List Price
RSI4MHT-LV	3/4" MHT	\$13.55
RSI45-LV	500 BARB	\$14.84
RSI455-LV	550 BARB	\$14.84
RSI46-LV	600 BARB	\$14.84
RSI47-LV	700 BARB	\$14.84
RSI48-LV	800 BARB	\$14.84

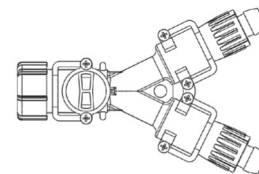

2 OUTLET WYE - BALL VALVE - SWIVEL

BALL VALVE WITH 3/4" FHT SWIVEL INLET
AND 2 WYE BARB OUTLETS OR 3/4" MHT OUTLETS

Part #	Outlet	List Price
RYFHT-MHT	3/4" MHT	\$8.77
RYFHT-5	500 BARB	\$9.39
RYFHT-55	550 BARB	\$9.39
RYFHT-6	600 BARB	\$9.39
RYFHT-7	700 BARB	\$9.39
RYFHT-8	800 BARB	\$9.39

COMBINATION ASSEMBLY EXAMPLE

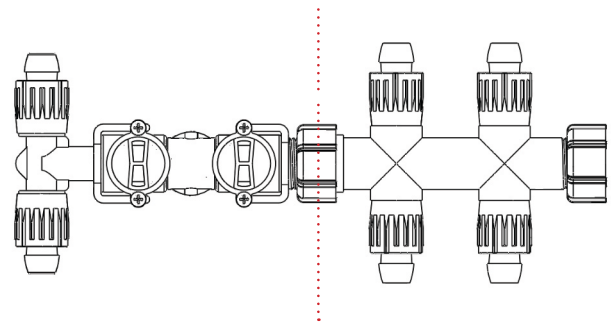
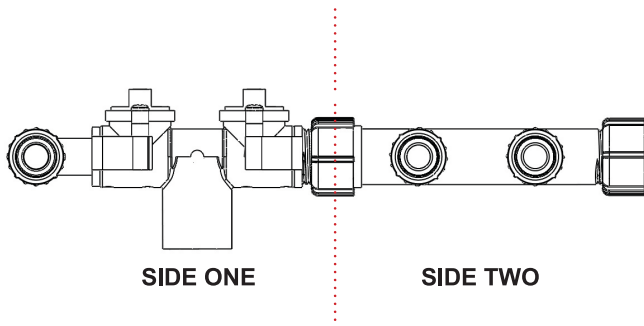

PART NUMBERS

Side One Part #	Side Two Part #
RVTT5-MHT	RSI45
RVTT55-MHT	RSI455
RVTT6-MHT	RSI46
RVTT7-MHT	RSI47
RVTT8-MHT	RSI48

EXAMPLE ORDER

Side One Part #	Side Two Part #
RVTT8-MHT / RSI46	800 Outlet on Tee and 600 Outlets on 4 way Manifold.

FLUSHING MANIFOLDS

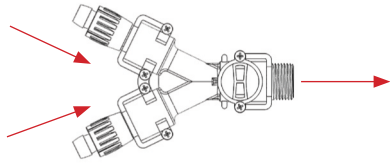

2 INLET WYE- BALL VALVE

2 WYE BARB INLETS OR 3/4" MHT INLETS
AND BLANK OUTLET

Part #	Inlet	List Price
RYMHT	3/4" MHT	\$7.35
RY5	500 BARB	\$7.35
RY55	550 BARB	\$7.35
RY6	600 BARB	\$7.35
RY7	700 BARB	\$7.35
RY8	800 BARB	\$7.35

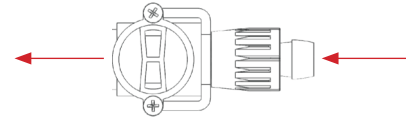

STRAIGHT INLET - BALL VALVE

BARB INLET OR 3/4" MHT INLETS
AND BLANK OUTLET

Part #	Inlet	List Price
RFMHT	3/4" MHT	\$4.60
RF5	500 BARB	\$4.91
RF55	550 BARB	\$4.91
RF6	600 BARB	\$4.91
RF7	700 BARB	\$4.91
RF8	800 BARB	\$4.91

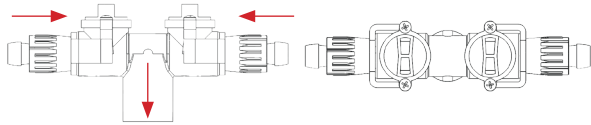

2 INLET TEE - BALL VALVES

2 BARB INLETS OR 3/4" MHT INLETS
AND 3/4" SOC / 1" SPIGOT OUTLET

Part #	Inlet	List Price
RVFT-MHT	3/4" MHT	\$8.83
RVFT-5	500 BARB	\$9.39
RVFT-55	550 BARB	\$9.39
RVFT-6	600 BARB	\$9.39
RVFT-7	700 BARB	\$9.39
RVFT-8	800 BARB	\$9.39



FIGURE 8

FIGURE "8" .600x.700 END CLOSURE

Part #	List Price	Bag Qty	Box Qty
RE-005	\$0.17	100	3000

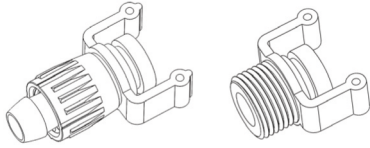

FIGURE 8

FIGURE "8" END CLOSURE

Part #	Size	List Price	Bag Qty	Box Qty
RE-075	3/4"	\$0.23	100	1000
RE-010	1"	\$0.27	100	1000

REPAIR KITS



BARB AND MHT REPAIR KIT

KITS INCLUDE: 2 SCREWS, LOCK NUT, BARB, 2 O-RINGS

Part #	Outlet	List Price
RVRK-MHT	MHT	\$3.62
RVRK-5	500 BARB	\$3.62
RVRK-55	550 BARB	\$3.62
RVRK-6	600 BARB	\$3.62
RVRK-7	700 BARB	\$3.62
RVRK-8	800 BARB	\$3.62

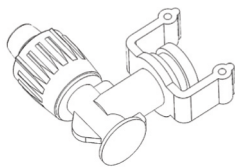

BARB ELL REPAIR KIT

KITS INCLUDE: 2 SCREWS, LOCK NUT, BARB, 2 O-RINGS

Part #	Outlet	List Price
RVRK-ELL-5	500 BARB	\$6.01
RVRK-ELL-55	550 BARB	\$6.01
RVRK-ELL-6	600 BARB	\$6.01
RVRK-ELL-7	700 BARB	\$6.01
RVRK-ELL-8	700 BARB	\$6.01

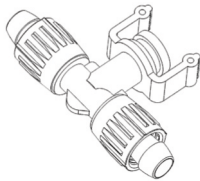

BARB TEE REPAIR KIT

KITS INCLUDE: 2 SCREWS, LOCK NUT, BARB, 2 O-RINGS

Part #	Outlet	List Price
RVRK-TEE-5	500 BARB	\$6.14
RVRK-TEE-55	550 BARB	\$6.14
RVRK-TEE-6	600 BARB	\$6.14
RVRK-TEE-7	700 BARB	\$6.14
RVRK-TEE-8	800 BARB	\$6.14

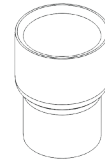

DEEP SOCKET INLET REPAIR COUPLER

1" SOCKET x 3/4" SOCKET / 1" SPIGOT

Part #	List Price
RVRC	\$1.25



BALL VALVE REPAIR KIT

KITS INCLUDE: 2 SCREWS, 2 O-RINGS, BALL W/ TOP O-RING, OPEN/CLOSE KNOB

Part #	List Price
RVRK-BV	\$3.62
RVRK-BV-BR	\$3.92

PVC Ball Valves



1/2" to 2 - 1/2"



3" and 4"

FEATURES

- PVC handle/lever
- Industrial Grade, Maintenance Free Design
- Fully ported opening
- One piece PVC molded body, Leak tested 100%
- Available with female NPT or slip / socket connections
- Applications include: Irrigation, Water Supply, Plumbing, Swimming Pool, Chemical Feed, Marine and Waste Water

OPERATING SPECIFICATIONS

- Pressure Ratings:
 1/2" - 2" Valves rated at 200 psi @ 70°F
 2 1/2" - 4" Valves rated at 150 psi @ 70°F
- Temperature Operating range is from 41°F to 122°F
- EPDM seat and O-ring

DETAILED SPECIFICS

PART #	SIZE	SCHEDULE CLASS	PRESSURE RATED AT 70F
BVT-005/BVS-005	1/2"	40	200 PSI
BVT-007/BVS-007	3/4"	40	200 PSI
BVT-010/BVS-010	1"	40	200 PSI
BVT-012/BVS-012	1 - 1/4"	40	200 PSI
BVT-015/BVS-015	1 - 1/2"	40	200 PSI
BVT-020/BVS-020	2"	40	200 PSI
BVT-025/BVS-025	2 - 1/2"	40	150 PSI
BVT-030/BVS-030	3"	40	150 PSI
BVT-040/BVS-040	4"	40	150 PSI

DIMENSIONS

PART #	L1	L2	H1	H2
BVT-005/BVS-005	3	0.87	1.98	2.49
BVT-007/BVS-007	3.45	0.90	2.11	3.02
BVT-010/BVS-010	3.91	1.00	2.21	3.42
BVT-012/BVS-012	4.35	1.06	2.45	3.83
BVT-015/BVS-015	5.00	1.20	2.97	4.26
BVT-020/BVS-020	5.75	1.50	3.43	5.10
BVT-025/BVS-025	6.82	1.57	3.91	6.53
BVT-030/BVS-030	9.38	2.50	4.42	7.42
BVT-040/BVS-040	10.38	2.56	5.05	8.23

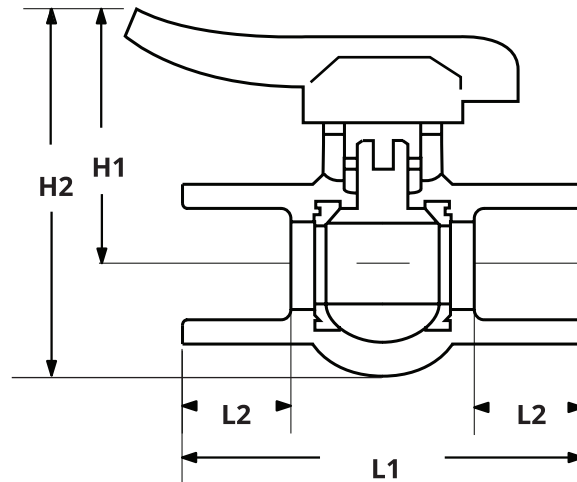

ORDER GUIDE

THREADED MODEL	SLIP MODEL	CASE QTY	LIST PRICE
BVT-005 = 1/2" Threaded PVC Ball Valve	BVS-005 = 1/2" Slip PVC Ball Valve	100	\$3.24
BVT-007 = 3/4" Threaded PVC Ball Valve	BVS-007 = 3/4" Slip PVC Ball Valve	60	\$4.79
BVT-010 = 1" Threaded PVC Ball Valve	BVS-010 = 1" Slip PVC Ball Valve	40	\$8.05
BVT-012 = 1 - 1/4" Threaded PVC Ball Valve	BVS-012 = 1 - 1/4" Slip PVC Ball Valve	25	\$11.49
BVT-015 = 1 - 1/2" Threaded PVC Ball Valve	BVS-015 = 1 - 1/2" Slip PVC Ball Valve	15	\$14.82
BVT-020 = 2" Threaded PVC Ball Valve	BVS-020 = 2" Slip PVC Ball Valve	10	\$23.02
BVT-025 = 2 - 1/2" Threaded PVC Ball Valve	BVS-025 = 2 - 1/2" Slip PVC Ball Valve	5	\$48.14
BVT-030 = 3" Threaded PVC Ball Valve	BVS-030 = 3" Slip PVC Ball Valve	2	\$91.89
BVT-040 = 4" Threaded PVC Ball Valve	BVS-040 = 4" Slip PVC Ball Valve	4	\$175.36

Automatic Irrigation Control

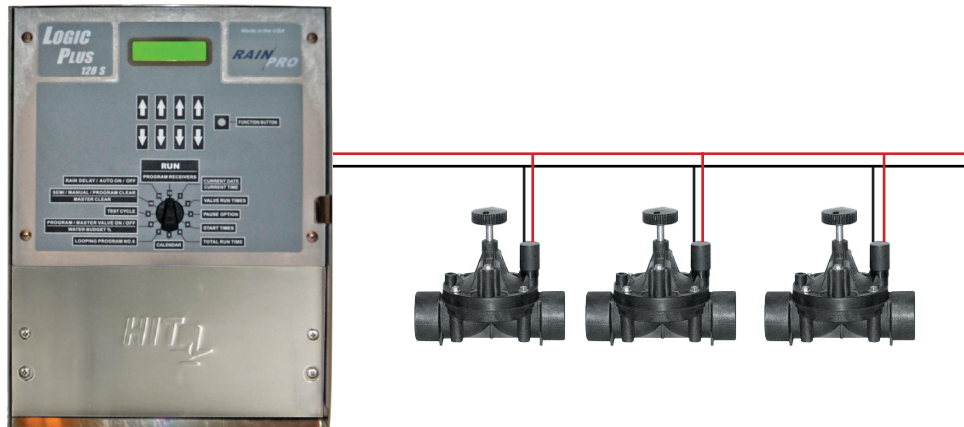

Logic Plus S - 2 Wire Controller

FEATURES

- 42 station capability / 128 station capability.
- 8 programs / 16 programs.
- 8 start times per program / 16 start times per program.
- Looping feature on program 6 and remote sensor relay to activate program 6.
- 1 minute to 10 hr 59 minutes run time per station (all programs except 5 and 6 which are 1 second to 59 minutes 59 seconds)
- Water budget 0-250% (5% increments) increasing run times per station to over 24 hours.
- Semi automatic and programmable manual operations.
- Programmable pause between stations per program 0-59 seconds.
- Programmable rain delay up to 31 days.
- Programmable master valve.
- Fertiligation control relays with fertigation programming.
- Date/leap year sensitive scheduling options weekly, 1-28 day interval.
- odd /even calendar day capabilities.
- Programmable test cycle.
- “Bounce back” technology allows programs to immediately continue on schedule after power outage.
- Radio remote ready.
- Program start input.
- Clear function for each independent program or entire controller.
- Displays real time operation.
- Up to 4 valves may operate simultaneously, same or different valve numbers.
- 4 field wire outputs, wire run lengths up to 12,000 feet each in four different directions.
- Field wires may be installed with tee, crosses and star wire configurations.
- Each valve has dedicated unique programmable receiver.
- Receivers can be programmed at controller or by way of portable programming unit, Model #LP-HHRP.

ORDER GUIDE

PART #	DESCRIPTION	CASE QTY	LIST PRICE
LP42S-C	1-42 Station, 8 Program, 8 Starts per program, 4 path, two-wire output controller in stainless steel locking enclosure. Requires one “LP-RP” programmable receiver per valve.	1	\$2,381.98
LP128S-C	1-128 Station, 16 program, 16 Starts per program, 4 path two-wire output controller in stainless steel locking enclosure. Requires one “LP-RP” programmable receiver per valve.	1	\$3,449.01
LP-RP	Programmable Receiver for LogicPLUS Controllers and LP-UNI-2. Programming of receiver requires a LP-42, LP-128 Controller or LP-HHRP. The LP-UNI-2 utilizes the LP-RP receiver. Each case of 16 LP-RP contains one each #1-#128 receiver identification tag kits. Each LP-RP also includes a pair of DBC-BR brass, waterproof wire connectors for splice to two-wire path.	16	\$167.43
LP-SPD-F	Surge Protection Device for field wiring of two-wire path. To be installed approximately every 300 - 500 ft along two-wire path. Install with grounding rod (not included). Include DBC-BR Wire Connectors Kit.	1	\$90.64
LP-UNI-2	Universal 2 Plus, 1 to 40 Station Two-Wire System Converter with dual output in stainless steel enclosure (requires one receiver per valve-sold separately part no. LP-RP)	1	\$1,855.48
DBC-R/Y	1 Kit consists of 2 water proof, direct bury, gel-filled splice housings, 2 R/Y 3M wire nuts and 1 splice organizer in a bag.	100 kit	\$5.83
DBC-BR	Logic Receiver Waterproof brass splice kit with direct bury, gel-filled housing for Receiver to Two-wire path connection. Two connectors per kit includes splice organizer.	100 kit	\$12.08

500 Series Straight Flow Valves

Available in 1", 1.5", 2" and 3"

FEATURES

- Straight through flow path
- Extremely low pressure loss
- High gallon
- 200 PSI rating
- Stainless steel hardware
- 24 VAC solenoid
- 5 year warranty

ELECTRICAL SPECIFICATIONS

- 24 VAC standard
- Inrush: 350 mA
- Holding: 250 mA
- Cycles: 50 Hz to 60 Hz

OPERATING SPECIFICATIONS

- 1" Flow: 1 GPH - 50 GPM
- 1 1/2" Flow: 1 - 110 GPM
- 2" Flow: 2 - 250 GPM
- 3" Flow: 5 GPM - 250 GPM
- Operating pressure: 15 to 200 PSI
- Recommended velocity not to exceed 5 feet per second of corresponding pipe size
- All valves for outdoor and installation only

OPTIONS AVAILABLE

- Pressure Regulation Device
- Normally Open Valves
- Normally Closed Valves

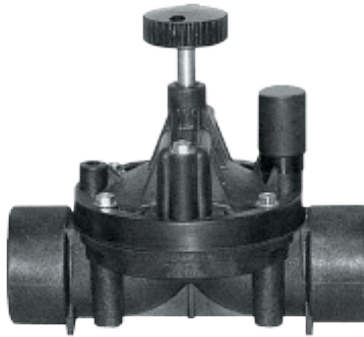

520-050

2" Nylon Female Thread inlet and outlet
Flow Control
Overall Height: 8"
Overall Width: 5 - 3/4"
Overall Length 8 - 1/4"

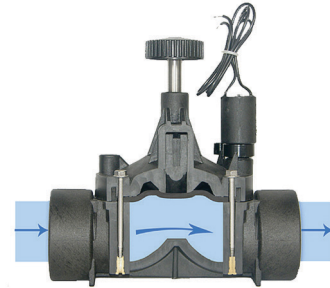

A straight flow valve has a patented open flow design. There are no 90 degree angles that the flow of water has to maneuver around. This allows for flow rates as far low as 1 GPH. The diaphragm inside does not cause hammering when closing like a typical diaphragm operated valve.

ORDER GUIDE

PART #	DESCRIPTION	CASE QTY	LIST PRICE
510-000	1" glass filled nylon straight flow valve without flow control, internal manual bleed, threaded ports, 6 bolt pattern, 24VAC	12	\$110.40
510-000-P	510-000 with pressure regulating, without flow control	12	\$213.75
510-050	1" glass filled nylon straight flow valve with internal manual bleed, stainless steel flow control stem, threaded ports, 6 bolt pattern, 24VAC, Normally closed	12	\$117.68
510-050-P	510-050 with pressure regulating	12	\$250.83
510-050-NO	1" glass filled nylon straight flow valve stainless steel flow control and fasteners, 24VAC, Normally Open (Valve closes when activated)	12	\$390.57
515-050	1-1/2" glass filled nylon straight flow valve with internal manual bleed, stainless steel flow control stem, threaded ports, 6 bolt pattern, 24VAC, Normally closed	8	\$155.05
515-050-P	515-050 with pressure regulating	8	\$274.73
515-050-NO	1-1/2" glass filled nylon straight flow valve stainless steel flow control and fasteners, 24VAC, Normally Open (Valve closes when activated)	8	\$428.94
520-050	2" glass filled nylon straight flow valve with internal manual bleed, stainless steel flow control stem, threaded ports, 6 bolt pattern, 24VAC, Normally closed	8	\$193.82
520-050-P	520-050 with pressure regulating	8	\$316.58
520-050-NO	2" glass filled nylon straight flow valve stainless steel flow control and fasteners, 24VAC, Normally Open (Valve closes when activated)	8	\$467.33
530-050	3" glass filled nylon straight flow valve with internal manual bleed, stainless steel flow control stem, threaded ports, 6 bolt pattern, 24VAC, Normally closed	8	\$571.79
530-050-P	530-050 with pressure regulating	8	\$706.06
530-050-NO	3" glass filled nylon straight flow valve stainless steel flow control and fasteners, 24VAC, Normally Open (Valve closes when activated)	8	\$844.68

Add \$15.00 to list price for 110 VAC solenoid in lieu of 24 VAC solenoid. Standard with NPT threaded ports. Consult factory for BSP threaded ports and 50 hertz solenoids. Valve design covered by patent # 5,632,465. All solenoid wire leads are factory "solder tinned"

Low Flow Products

HYDRO-PRO ADJUSTABLE JETS

Part #	Description	Color	List Price	Bag Qty	Box Qty
RPVF	0-25 GPH, adjustable jet body only (use with HYDRO-PRO RPTFC cap, 10-32 NPT inlet)	Black	\$1.61	100	500
RPVF 360	0-25 GPH, adjustable flow jet (360° pattern-stream spray, 10-32 NPT inlet)	Black	\$1.93	100	500
RPVF 180	0-25 GPH, adjustable flow jet (180° pattern - fan spray, 10-32 NPT inlet)	Black	\$1.93	100	500
RPVF 90	0-25 GPH, adjustable flow jet (90° pattern - fan spray, 10-32 NPT inlet)	Black	\$1.93	100	500

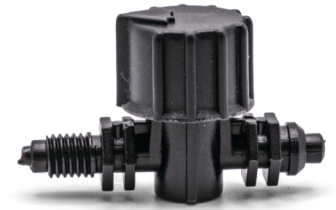

MICRO-SPRINKLER

Part #	Description	Color	List Price	Bag Qty	Box Qty
RPMFA	0 - 25 GPH, adjustable flow micro-sprinkler with shut - off (10-32 inlet)	Black	\$2.97	50	300



DIAL - A - PRO-EMITTERS

Part #	Description	Color	List Price	Bag Qty	Box Qty
RPDAFB 360	360° 8 stream, 0-10 GPH, adjustable DIAL-A-PRO emitter with barbed inlet	Black	\$0.72	100	2,500
RPDAFB 180	180° 5 stream, 0-10 GPH, adjustable DIAL-A-PRO emitter with barbed inlet	Black	\$0.72	100	2,500
RPDAFB FAN	360° Fan Spray 0-20 GPH, adjustable DIAL-A-PRO emitter with barbed inlet	Black	\$0.89	100	2,500
RPDAFB BUB	Umbrella Bubbler 0-25 GPH, adjustable DIAL-A-PRO emitter with barbed inlet	Black	\$0.89	100	2,500
RPDAFT 360	360° 8 stream, 0-10 GPH, adjustable DIAL-A-PRO emitter with 10-32 NPT inlet	Black	\$0.89	100	2,500
RPDAFT 180	180° 5 stream, 0-10 GPH, adjustable DIAL-A-PRO emitter with 10-32 NPT inlet	Black	\$0.89	100	2,500
RPDAFT FAN	360° Fan Spray 0-20 GPH, adjustable DIAL-A-PRO emitter with 10-32 NPT inlet	Black	\$0.89	100	2,500
RPDAFT BUB	Umbrella Bubbler, 0-25 GPH adjustable DIAL-A-PRO emitter with 10-32 NPT inlet	Black	\$0.89	100	2,500
RPDAFS 360	360° 8 stream, 0-10 GPH, adjustable DIAL-A-PRO emitter with 6" stake	Black	\$1.08	100	1,000
RPDAFS 180	180° 5 stream, 0-10 GPH, adjustable DIAL-A-PRO emitter with 6" stake	Black	\$1.08	100	1,000
RPDAFS FAN	360° Fan Spray, 0-20 GPH, adjustable DIAL-A-Pro emitter with 6" stake	Black	\$1.17	100	1,000
RPDAFS BUB	Umbrella Bubbler, 0-25 GPH, adjustable DIAL-A-PRO emitter with 6" stake	Black	\$1.17	100	1,000
RPDAFU 360	360° 8 stream, 0-10 GPH, adjustable DIAL-A-PRO emitter with 1/2" FIPT inlet	Black	\$1.41	50	500
RPDAFU 180	180° 5 stream, 0-10 GPH, adjustable DIAL-A-PRO emitter with 1/2" FIPT inlet	Black	\$1.41	50	500
RPDAFU FAN	360° Fan Spray, 0-20 GPH, adjustable DIAL-A-PRO emitter with 1/2" FIPT inlet	Black	\$1.47	50	500
RPDAFU BUB	Umbrella Bubbler, 0-25 GPH, adjustable DIAL-A-PRO emitter with 1/2" FIPT inlet	Black	\$1.47	50	500



OMNI-PRO FLOW CONTROLLERS

Part #	Description	Color	List Price	Bag Qty	Box Qty
RPOF 2	2 GPH, pressure compensating, 1/4" barb, inline flow controller	Gray	\$0.89	100	2000
RPOF 6	6 GPH, pressure compensating, 1/4" barb, inline flow controller	Orange	\$0.89	100	2000
RPOF 10	10 GPH, pressure compensating, 1/4" barb, inline flow controller	Violet	\$0.89	100	2000
RPOF 20	20 GPH, pressure compensating, 1/4" barb, inline flow controller	Brown	\$0.89	100	2000



ISO-PRO EMITTER

Part #	Description	Color	List Price	Bag Qty	Box Qty
RPIF 5	1/2 GPH pressure compensating emitter with outlet nipple	Red	\$0.57	100	2000
RPIF 10	1 GPH pressure compensating emitter with outlet nipple	Black	\$0.57	100	2000
RPIF 20	2 GPH pressure compensating emitter with outlet nipple	Green	\$0.57	100	2000



PC-PRO EMITTERS

Part #	Description	Color	List Price	Bag Qty	Box Qty
RPPCP 5	1/2 GPH turbulent flow, pressure compensating emitter, self piercing barb	Red	\$0.70	100	2500
RPPCP 10	1 GPH turbulent flow, pressure compensating emitter, self piercing barb	Black	\$0.70	100	2500
RPPCP 20	2 GPH turbulent flow, pressure compensating emitter, self piercing barb	Green	\$0.70	100	2500
RPPC 5	1/2 GPH turbulent flow, pressure compensating emitter with outlet nipple	Red	\$0.70	100	2500
RPPC 10	1 GPH turbulent flow, pressure compensating emitter with outlet nipple	Black	\$0.70	100	2500
RPPC 20	2 GPH turbulent flow, pressure compensating emitter with outlet nipple	Green	\$0.70	100	2500



SUPER-PRO EMITTERS

Part #	Description	Color	List Price	Bag Qty	Box Qty
RPTAE 10	1 GPH, laminar flow, take apart emitter	Black	\$0.42	100	2000
RPTAE 20	2 GPH, laminar flow, take apart emitter	Green	\$0.42	100	2000
RPTAE 40	3 GPH, laminar flow, take apart emitter	Blue	\$0.42	100	2000



INLINE-PRO EMITTERS

Part #	Description	Color	List Price	Bag Qty	Box Qty
RPIL 165	1/2 GPH, turbulent flow emitter (use .620 tubing)	Black	\$0.42	50	800
RPIL 1610	1 GPH, turbulent flow emitter (use .620 tubing)	Black	\$0.42	50	800
RPIL 1620	2 GPH, turbulent flow emitter (use .620 tubing)	Black	\$0.42	50	800



AQUA-PRO EMITTERS

Part #	Description	Color	List Price	Bag Qty	Box Qty
RPAFB 5	1/2 GPH clip-on, turbulent flow emitter, use .250 tubing	Red	\$0.42	50	800
RPAFB 10	1 GPH clip-on, turbulent flow emitter, use .250 tubing	Black	\$0.42	100	2000
RPAFB 20	2 GPH clip-on turbulent flow emitter, use .250 tubing	Green	\$0.42	100	2000
RPAFT 5	1/2 GPH screw-on, turbulent flow emitter (use .185 tubing), 10-32 thread	Red	\$0.37	100	2000
RPAFT 10	1 GPH screw-on, turbulent flow emitter (use .185 tubing), 10-32 thread	Black	\$0.37	100	2000
RPAFT 20	2 GPH screw-on, turbulent flow emitter (use .185 tubing), 10-32 thread	Green	\$0.42	100	2000
RPAFTS 5	1/2 GPH turbulent flow emitter with stake (use .185 tubing) 10-32 thread	Red	\$0.42	100	2000
RPAFTS 10	1 GPH turbulent flow emitter with stake (use .185 tubing), 10-32 thread	Black	\$0.42	100	2000
RPAFTS 20	2 GPH screw-on, turbulent flow emitter with stake (use .185 tubing), 10-32 thread	Green	\$0.43	100	2000
RPAFS 5	1/2 GPH, mini-inline emitter with stake (use .250 tubing)	Red	\$0.58	100	2000
RPAFS 10	1 GPH mini-inline emitter with stake (use .250 tubing)	Black	\$0.58	100	2000
RPAFS 20	2 GPH, mini-inline emitter with stake (use .250 tubing)	Green	\$0.58	100	2000



MINI-PRO INLINE

Part #	Description	Color	List Price	Bag Qty	Box Qty
RPAFBB 5	1/2 GPH, mini-inline emitter (use .250 tubing)	Red	\$0.48	100	2000
RPAFBB 10	1 GPH, mini-inline emitter (use .250 tubing)	Black	\$0.48	100	2000
RPAFBB 20	2 GPH, mini-inline emitter (use .250 tubing)	Green	\$0.46	100	2000



MICRO-PRO MICRO SPRINKLERS

Part #	Description	Color	List Price	Bag Qty	Box Qty
RPMF 35	Full-circle micro sprinkler, 10-32 NPT, 0.35 orifice	Brown	\$1.52	100	500
RPMF 40	Full-circle micro sprinkler, 10-32 NPT, 0.40 orifice	Blue	\$1.52	100	500
RPMF 50	Full-circle micro sprinkler, 10-32 NPT, 0.50 orifice	Green	\$1.52	100	500



STATO-PRO JETS

Part #	Description	Color	List Price	Bag Qty	Box Qty
RPSF 32	360° jet, 1/8" MIPT inlet, 0.032" orifice	Green	\$0.71	100	1000
RPSF 42	360° jet, 1/8" MIPT inlet, 0.042" orifice	White	\$0.71	100	1000
RPSF 52	360° jet, 1/8" MIPT inlet, 0.052" orifice	Red	\$0.71	100	1000
RPSF 70	360° jet, 1/8" MIPT inlet, 0.070" orifice	Black	\$0.71	100	1000



ROTO-PRO MINI SPRINKLERS

Part #	Description	Color	List Price	Bag Qty	Box Qty
RPRF 55	Full-circle mini-sprinkler, 3/8" MIPT, .055" orifice	Brown	\$1.70	100	600
RPRF 64	Full-circle mini-sprinkler, 3/8" MIPT, .064" orifice	Green	\$1.70	100	600
RPRF 72	Full-circle mini-sprinkler, 3/8" MIPT, .072" orifice	Blue	\$1.70	100	600
RPRF 80	Full-circle mini-sprinkler, 3/8" MIPT, .080" orifice	Grey	\$1.70	100	600
RPRF 87	Full-circle mini-sprinkler, 3/8" MIPT, .087" orifice	Yellow	\$1.70	100	600
RPRF 93	Full-circle mini-sprinkler, 3/8" MIPT, .093" orifice	Red	\$1.70	100	600
RPRFF 55	Full-circle mini-sprinkler, 1/2" MIPT, .055" orifice	Brown	\$1.70	100	600
RPRFF 64	Full-circle mini-sprinkler, 1/2" MIPT, .064" orifice	Green	\$1.70	100	600
RPRFF 72	Full-circle mini-sprinkler, 1/2" MIPT, .072" orifice	Blue	\$1.70	100	600
RPRFF 80	Full-circle mini-sprinkler 1/2" MIPT .080" orifice	Grey	\$1.70	100	600
RPRFF 87	Full-circle mini-sprinkler 1/2" MIPT, .087" orifice	Yellow	\$1.70	100	600
RPRFF 93	Full-circle mini-sprinkler 1/2" MIPT .093" orifice	Red	\$1.70	100	600



HYDRO-PRO JETS

Part #	Description	Color	List Price	Bag Qty	Box Qty
RPTFC 360	Cap - 360°, 12 finger spray	Black	\$0.26	100	2500
RPTFC 300	Cap - 300°, 10 finger spray	Black	\$0.26	100	2500
RPTFC 180	Cap - 180° fan spray	Black	\$0.26	100	2500
RPTFC 90	Cap - 90° fan spray	Black	\$0.26	100	2500
RPTFC 33	Cap - strip fan spray	Black	\$0.26	100	2500
RPTFB 30	Base - 0.030" nozzle	Black	\$0.26	100	2500
RPTFB 40	Base - 0.040" nozzle	Blue	\$0.26	100	2500
RPTFB 50	Base - 0.050" nozzle	Green	\$0.26	100	2500
RPTFB 60	Base - 0.060" nozzle	Red	\$0.26	100	2500
RPTFB 70	Base - 0.070" nozzle	White	\$0.26	100	2500
RPTF 336	0.030" nozzle, 360° fan spray single piece jet	Black	\$0.30	100	2500
RPTF 436	0.040" nozzle, 360° fan spray single piece jet	Blue	\$0.30	100	2500
RPTF 536	0.050" nozzle, 360° fan spray single piece jet	Green	\$0.30	100	2500
RPTF 636	0.060" nozzle, 360° fan spray single piece jet	Red	\$0.30	100	2500
RPTF 318	0.030" nozzle, 180° fan spray single piece jet	Black	\$0.30	100	2500
RPTF 418	0.040" nozzle, 180° fan spray single piece jet	Blue	\$0.30	100	2500
RPTF 518	0.050" nozzle, 180° fan spray single piece jet	Green	\$0.30	100	2500
RPTF 618	0.060" nozzle, 180° fan spray single piece jet	Red	\$0.30	100	2500
RPTF 39	0.030" nozzle, 90° fan spray single piece jet	Black	\$0.30	100	2500
RPTF 49	0.040" nozzle, 90° fan spray single piece jet	Blue	\$0.30	100	2500
RPTF 59	0.050" nozzle, 90° fan spray single piece jet	Green	\$0.30	100	2500
RPTF 69	0.060" nozzle, 90° fan spray single piece jet	Red	\$0.30	100	2500



RAIN PRO RISER

Part #	Description	Color	List Price	Bag Qty	Box Qty
RPR 6	6" riser extension (0.160" ID x 0.300" OD)	Black	\$0.23	100	2000
RPR 8	8" riser extension (0.160" ID x 0.300" OD)	Black	\$0.25	100	1500
RPR 12	12" riser extension (0.160" ID x 0.300" OD)	Black	\$0.37	100	1000
RPR 18	18" riser extension (0.160" ID x 0.300" OD)	Black	\$0.52	100	600



PRO RISER ASSEMBLIES .300 OD x .160 ID

Part #	Description	Color	List Price	Bag Qty	Box Qty
RPRATT 6	6" riser (.160" ID) with threaded adapter	Black	\$0.65	100	1500
RPRATT 8	8" riser (. 160" ID) with threaded adapter	Black	\$0.69	100	1500
RPRATT 12	12" riser (.160" ID) with threaded adapter	Black	\$0.81	100	1000
RPRATT 18	12" riser (. 160" ID) with threaded adapter	Black	\$0.98	N/A	600
RPRABT 6	6" riser (.160" ID) with barbed adapter	Black	\$0.66	100	1500
RPRABT 8	8" riser (.160" ID) with barbed adapter	Black	\$0.69	100	1500
RPRABT 12	12" riser (.160" ID) with barbed adapter	Black	\$0.81	100	1000
RPRABT 18	18" riser (.160" ID) with barbed adapater	Black	\$0.98	N/A	600



MICRO-PRO FITTINGS

Part #	Description	Color	List Price	Bag Qty	Box Qty
RPDBA	Adapter - 2 size barb x barb (fits 0.125" andd 0.160" / 0.170" ID tubing)	Black	\$0.23	100	5000
RPBT 125	Adapter - barb x thread (fits 0.125" ID tubing)	Black	\$0.28	100	2000
RPBT 250	Adapter - barb x thread (fits 0.160" ID - 0.170" ID tubing)	Black	\$0.28	100	2000
RPTT 250	Adapter - thread x thread (fits 0.160" ID - 0.170" ID tubing)	Black	\$0.23	100	2000
RPBB 125	Connector (barb x barb) short body (fits 0.160" ID - 0.170" ID tubing)	Black	\$0.14	100	2000
RPC 125	Connector (barb x barb) short body (fits 0.125" ID tubing)	Black	\$0.14	100	2000
RPC 250	Connector (barb x barb) long body (fits 0.160" ID - 0.170" ID tubing)	Black	\$0.17	100	10000
RPBB 250	Adapter (barb x barb) (fits 0.160" ID - 0.170" ID tubing)	Black	\$0.17	100	5000
RPT 125	Tee (barb x barb x barb) (fits 0.160" ID - 0.170" ID tubing)	Black	\$0.35	100	2000
RPT 250	Tee (barb x barb x barb) (fits 0.160" ID - 0.170" ID tubing)	Black	\$0.25	100	3000
RPEL 250	Elbow (barb x barb) (fits 0.160" ID - 0.170" ID tubing)	Black	\$0.22	100	5000
RPGP 2	Dual goof plug (20/rack)	Black	\$0.08	100	10000
RPGP 2B	Bulk packaged 2 sided goof plug	Black	\$0.06	100	10000



SOLVENT WELD PRO ADAPTER

Part #	Description	Color	List Price	Bag Qty	Box Qty
RPCA 250	Compression adapter (short) (1/2" slip x .250" OD tubing)	Orange	\$0.36	100	2000
RPCA300	Compression adapter (short) (1/2" slip x .307" OD tubing)	Grey	\$0.36	100	2000
RPCA 500	Compression adapter (short) (1/2" slip x .455-.480" OD tubing)	Red	\$0.36	100	2000
RPCA 580	Compression adapter (short) (1/2" slip x .580" OD tubing)	Yellow	\$0.36	100	2000
RPCA 600	Compression adapter (short) (1/2" slip x .610-.640" OD tubing)	Green	\$0.36	100	2000
RPCA 660	Compression adapter (short) (1/2" slip x .660" OD tubing)	Brown	\$0.36	100	2000
RPCA 700	Compression adapter (short) (1/2" slip x .680-.704" OD tubing)	Black	\$0.36	100	2000
RPCA 710	Compression adapter (short) (1/2" slip x .704-.710" OD tubing)	Blue	\$0.36	100	2000
RPCA 800	Compression adapter (short) (3/4" slip x .830" OD tubing)	Black	\$0.60	100	2000
RPCA 900	Compression adapter (short) (3/4" slip x .940" OD tubing)	Grey	\$0.60	100	2000



Note: To be used on schedule 40 PVC fittings only.

PRO COMPRESSION COUPLINGS

Part #	Description	Color	List Price	Bag Qty	Box Qty
RPCC 500	Compression coupling (fits .455" to .480" OD tubing)	Red	\$0.95	25	1000
RPCC 600	Compression coupling (fits .610" to .640" OD tubing)	Green	\$0.95	25	1000
RPCC 700	Compression coupling (fits .704" to .710" OD tubing)	Black	\$0.95	25	1000
RPCC 710	Compression coupling (fits .704" to .710" OD tubing)	Blue	\$0.95	25	1000
RPCC 800	Compression coupling (fits .830" OD tubing)	Black	\$1.29	25	1000
RPCC 900	Compression coupling (fits .940" OD tubing)	Grey	\$1.29	25	1000



PRO COMPRESSION ELBOWS

Part #	Description	Color	List Price	Bag Qty	Box Qty
RPCEL 500	Compression elbow (fits .455" to .480" OD tubing)	Red	\$1.44	25	800
RPCEL 600	Compression elbow (fits .610" to .640" OD tubing)	Green	\$1.44	25	800
RPCEL 700	Compression elbow (fits .704" to .710" OD tubing)	Black	\$1.44	25	800
RPCEL 710	Compression elbow (fits .704" to .710" OD tubing)	Blue	\$1.44	25	800
RPCEL 800	Compression elbow (fits .830" OD tubing)	Black	\$2.02	25	800
RPCEL 900	Compression elbow (fits .940" OD tubing)	Grey	\$2.02	25	800



PRO COMPRESSION TEES

Part #	Description	Color	List Price	Bag Qty	Box Qty
RPCT 500	Compression tee (fits .455" to .480" OD tubing)	Red	\$1.44	15	480
RPCT 600	Compression tee (fits .610" to .640" OD tubing)	Green	\$1.44	15	480
RPCT 700	Compression tee (fits .704" to .710" OD tubing)	Black	\$1.44	15	480
RPCT 710	Compression tee (fits .704" to .710" OD tubing)	Blue	\$1.44	15	480
RPCT 800	Compression tee (fits .830" OD tubing)	Black	\$3.01	15	480
RPCT 900	Compression tee (fits .940" OD tubing)	Grey	\$3.01	15	480



PRO COMPRESSION END PLUGS

Part #	Description	Color	List Price	Bag Qty	Box Qty
RPCEP 500	End Plug w/ unscrewing cap (fits .455" to .480" OD tubing)	Red	\$1.44	25	800
RPCEP 600	End Plug w/ unscrewing cap (fits .610" to .640" OD tubing)	Green	\$1.44	25	800
RPCEP 700	End Plug w/ unscrewing cap (fits .704" to .710" OD tubing)	Black	\$1.44	25	800
RPCEP 710	End Plug w/ unscrewing cap (fits .704" to .710" OD tubing)	Blue	\$1.44	25	800
RPCEP 800	End Plug w/ unscrewing cap (fits .830" OD tubing)	Black	\$2.26	25	800
RPCEP 900	End Plug w/ unscrewing cap (fits .940" OD tubing)	Grey	\$2.26	25	800



PRO 3/4" SWIVEL ADAPTERS

Part #	Description	Color	List Price	Bag Qty	Box Qty
RPCSAW 500	3/4" FHT swivel adapter w/ washer (fits .455" to .480" OD tubing)	Red	\$1.53	25	800
RPCSAW 600	3/4" FHT swivel adapter w/ washer (fits .610" to .640" OD tubing)	Green	\$1.53	25	800
RPCSAW 700	3/4" FHT swivel adapter w/ washer (fits .704" to .710" OD tubing)	Black	\$1.53	25	800
RPCSAW 710	3/4" FHT swivel adapter w/ washer (fits .704" to .710" OD tubing)	Blue	\$1.53	25	800
RPCSAW 800	3/4" FHT swivel adapter w/ washer (fits .830" OD tubing)	Black	\$2.99	25	800
RPCSAW 900	3/4" FHT swivel adapter w/ washer (fits .940" OD tubing)	Grey	\$2.99	25	800



PRO 3/4" SWIVEL TEES

Part #	Description	Color	List Price	Bag Qty	Box Qty
RPCSTW 500	3/4" FHT swivel tee w/ washer (fits .455" to .480" OD tubing)	Red	\$1.91	15	480
RPCSTW 600	3/4" FHT swivel tee w/ washer (fits .610" to .640" OD tubing)	Green	\$1.91	15	480
RPCSTW 700	3/4" FHT swivel tee w/ washer (fits .704" to .710" OD tubing)	Black	\$1.91	15	480
RPCSTW 710	3/4" FHT swivel tee w/ washer (fits .704" to .710" OD tubing)	Blue	\$1.91	15	480
RPCSTW 800	3/4" FHT swivel tee w/ washer (fits .830" OD tubing)	Black	\$3.94	15	480
RPCSTW 900	3/4" FHT swivel tee w/ washer (fits .940" OD tubing)	Grey	\$3.94	15	480



PRO 3/4" MALE HOSE ADAPTERS

Part #	Description	Color	List Price	Bag Qty	Box Qty
RPCMAH 500	3/4" MHT adapter (fits .455" to .480" OD tubing)	Red	\$0.94	50	1000
RPCMAH 600	3/4" MHT adapter (fits .610" to .640" OD tubing)	Green	\$0.94	50	1000
RPCMAH 700	3/4" MHT adapter (fits .704" to .710" OD tubing)	Black	\$0.94	50	1000
RPCMAH 710	3/4" MHT adapter (fits .704" to .710" OD tubing)	Blue	\$0.94	50	1000
RPCMAH 800	3/4" MHT adapter (fits .830" OD tubing)	Black	\$1.66	50	1000
RPCMAH 900	3/4" MHT adapter (fits .940" OD tubing)	Grey	\$1.66	50	1000



PRO INSERT FITTINGS

Part #	Description	Color	List Price	Bag Qty	Box Qty
RPC 375	Insert barbed coupling (fits .455" tubing and 3/8" laser tubing)	Black	\$0.39	100	1000
RPC 520	Insert barbed coupling (fits .620 tubing)	Black	\$0.45	100	1000
RPC 600	Insert barbed coupling (fits .700 tubing)	Black	\$0.46	100	1000
RPT 375	Insert barbed tee (fits .455 tubing and 3/8" laser tubing)	Black	\$0.53	100	800
RPT 520	Insert barbed tee (fits .620 tubing)	Black	\$0.63	100	600
RPEL 375	Insert barbed elbow (fits .455 tubing and 3/8" laser tubing)	Black	\$0.95	100	500
RPEL 520	Insert barbed elbow (fits .620 tubing)	Black	\$1.25	100	400



PRO SWING RISER FITTINGS

Part #	Description	Color	List Price	Bag Qty	Box Qty
RPSBA 50	1/2" male NPT x barbed adapter	Black	\$0.81	50	500
RPSBA 75	3/4" male Npt x spiral barbed elbow	Black	\$0.81	50	500
RPSBEL 50	1/2" male NPT x spiral barbed elbow	Black	\$0.81	50	500
RPSBEL 75	1/2" spiral barbed coupler	Black	\$0.81	50	500
RPSBC 50	1/2" spiral barbed coupler	Black	\$0.75	50	500



PRO 1/2" RISER ADAPTERS

Part #	Description	Color	Price List	Bag Qty	Box Qty
RPRA250-1	1/2" Riser Adapter w/ 1/4" Barb outlet (1/2" FIPT x 1/2" MIPT w/one 1/4" barb)	Black	\$2.33	50	1000
RPRA250-2	1/2" Riser Adapter w/ two 1/4" Barb outlets (1/2" FIPT x 1/2" MIPT w/two 1/4" barbs)	Black	\$2.33	50	1000
RPSAJ	Adapter (1/2" FIPT x 10-32 NFT)	Black	\$1.08	100	1000
RPSAT	Adapter (3/4" FIPT x 1/4")	Black	\$1.43	50	1000
RPSFT	Adapter (3/4" FHT x 1/4" barb)	Gray	\$1.43	50	1000



BLANK END RISER ADAPTERS

Part #	Description	Color	Price List	Bag Qty	Box Qty
RPRB250-1	1/2" Riser Adapter Blank End w/ 1/4" Barb outlet (1/2" MIPT w/one 1/4" barb)	Black	\$0.97	50	1000
RPRB250-2	1/2" Riser Adapter Blank End w/ two 1/4" Barb outlets (1/2" MIPT w/two 1/4" barbs)	Black	\$0.97	50	1000



TUBING HOLE PUNCH

Part #	Description	Color	Price List	Bag Qty
RPTP	Ketone Material - Very hard and strong. Sharp point for over 10,000 insertions.	Yellow	\$3.18	20



PRO PLASTIC STAKES

Part #	Description	Color	Price List	Bag Qty	Box Qty
RPS 5	6" Plastic elbow stake with 1/4" barbed side inlet and 10/32 NFT top outlet flow control	Black	\$0.88	50	1500
RPS 6	6" Plastic stake (fits .185, .220 and .250 tubing)	Black	\$0.29	100	3000
RPS 7	6" Plastic stake to hold down 0.620" to 0.710" OD tubing	Black	\$0.63	25	700



PRO AUTOMATIC FLUSH VALVES

Part #	Description	Color	Price List	Bag Qty	Box Qty
RPFVA 500	Automatic flush valve - closes at 7 psi (fits .455" tp .480" OD tubing)	Red	\$3.77	25	500
RPFVA 600	Automatic flush valve - closes at 7 psi (fits .680" to .630" OD tubing)	Green	\$3.77	25	500
RPFVA 700	Automatic flush valve - closes at 7 psi (fits .680" to .704" OD tubing)	Black	\$3.77	25	500
RPFVA 710	Automatic flush valve - closes at 7 psi (fits .704" to .710" OD tubing)	Blue	\$3.77	25	500



PRO VALVES

Part #	Description	Color	Price List	Bag Qty	Box Qty
RPMVT 25	1/4" Flow Controlling Valve (thread x thread) (fits 0.160" ID x 0.300 OD risers)	Black	\$1.61	100	500
RPBV 75	3/4 FHT x 3/4" MHT ball valve	Green	\$3.35	25	150
RPFC 600	1/2" flow controlling valve (fits .610" to .630" OD tubing)	Green	\$2.96	25	200
RPFC 700	1/2" flow controlling valve (fits .680" to .704" OD tubing)	Black	\$2.96	25	200
RPFC 710	1/2" flow controlling valve (fits .704" to .710" OD tubing)	Blue	\$2.96	25	200

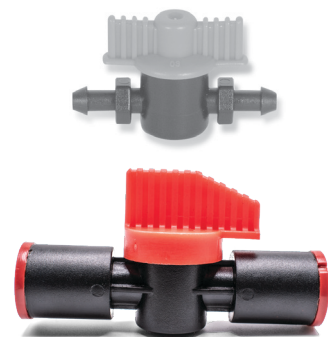

MISCELLANEOUS

Part #	Description	Color	Price List	Bag Qty	Box Qty
RPPU	Adapter for HYDRO-PRO jet and threaded DIAL-A-PRO (RP DAFT) emitter to pop-up sprinkler	Black	\$0.69	100	300
RPDTH	Drip tube hanger (fits .480" to .710" OD tubing)	Black	\$0.13	100	300



PRO PRESSURE REGULATORS

Part #	Description	Color	Price List	Bag Qty	Box Qty
RPPRP 15	15 psi, 3/4" female pipe thread x male pipe thread pressure regulator, .2 to 10 GPM	Black	\$13.45	10	50
RPPRP 25	25 psi, 3/4" female pipe thread x male pipe thread pressure regulator, .2 to 10 GPM	Black	\$13.45	10	50
RPPRP 45	45 psi, 3/4" female pipe thread x male pipe thread pressure regulator, .2 to 10 GPM	Black	\$13.45	10	50
RPPRH 15	15 psi 3/4" female hose thread x male hose thread pressure regulator, .2 to 10 GPM	Gray	\$13.45	10	50
RPPRH 25	25 psi, 3/4" female hose thread x male hose thread pressure regulator, .2 to 10 GPM	Gray	\$13.45	10	50
RPPRH 45	45 psi, 3/4" female hose thread x male hose thread pressure regulator, .2 to 10 GPM	Gray	\$13.45	10	50



Pipe Saddles

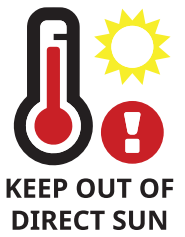

Pipe Size x 1/2" Socket / 3/4" Spigot Outlet

Part #	Size	Color	Price List	Bag Qty	Box Qty
SD-015-005	1 1/2 x 1/2	Black	\$1.00	25	250
SD-020-005	2 x 1/2	White	\$1.00	25	250
SD-025-005	2 1/2 x 1/2	Grey	\$1.00	25	250
SD-030-005	3 x 1/2	Brown	\$1.00	25	250
SD-040-005	4 x 1/2	Green	\$1.00	25	250
SD-050-005	5 x 1/2	Red	\$1.00	25	250
SD-060-005	6 x 1/2	Blue	\$1.00	25	250
SD-080/100-005	8 / 10 x 1/2	Orange	\$1.00	25	250
SD-120-005	12 x 1/2	Beige	\$1.00	25	250

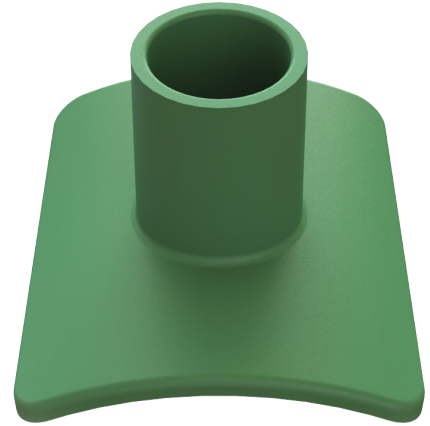

Pipe Size x 3/4" Socket / 1" Spigot Outlet

Part #	Size	Color	Price List	Bag Qty	Box Qty
SD-015-007	1 1/2 x 3/4	Black	\$1.05	25	250
SD-020-007	2 x 3/4	White	\$1.05	25	250
SD-025-007	2 1/2 x 3/4	Grey	\$1.05	25	200
SD-030-007	3 x 3/4	Brown	\$1.05	25	200
SD-040-007	4 x 3/4	Green	\$1.05	25	250
SD-050-007	5 x 3/4	Red	\$1.05	25	250
SD-060-007	6 x 3/4	Blue	\$1.05	25	250
SD-080/100-007	8 / 10 x 3/4	Orange	\$1.05	25	250
SD-120-007	12 x 3/4	Beige	\$1.05	25	250

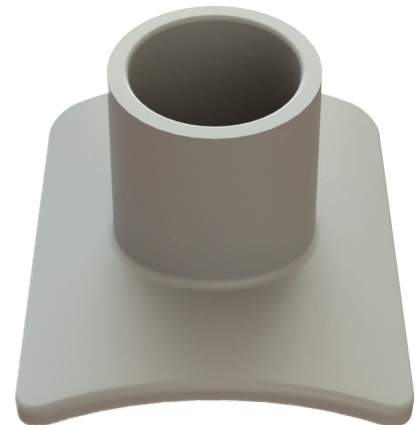

Pipe Size x 1" Socket / 1 1/4" Spigot Outlet

Part #	Size	Color	Price List	Bag Qty	Box Qty
SD-015-010	1 1/2 x 1	Black	\$1.20	25	200
SD-020-010	2 x 1	White	\$1.20	25	200
SD-025-010	2 1/2 x 1	Grey	\$1.20	25	200
SD-030-010	3 x 1	Brown	\$1.20	25	175
SD-040-010	4 x 1	Green	\$1.20	25	175
SD-050-010	5 x 1	Red	\$1.20	25	175
SD-060-010	6 x 1	Blue	\$1.20	25	175
SD-080/100-010	8 / 10 x 1	Orange	\$1.20	25	175
SD-120-010	12 x 1	Beige	\$1.20	25	175



Grooved Coupling

Grooved Fittings are a popular method of making pipe connections with larger diameter pipe in the Agricultural market. These fittings are compatible with grooved PVC pipe ranging in size from 2" through 12". Each cast iron fitting comes with a matching rubber seal and two brass bolts and nuts for a leak proof connection. Grooved fittings can be removed as needed and re-used with no gluing or cutting of pipe required.

FEATURES

Grooved flexible couplings have a 300 psi rating

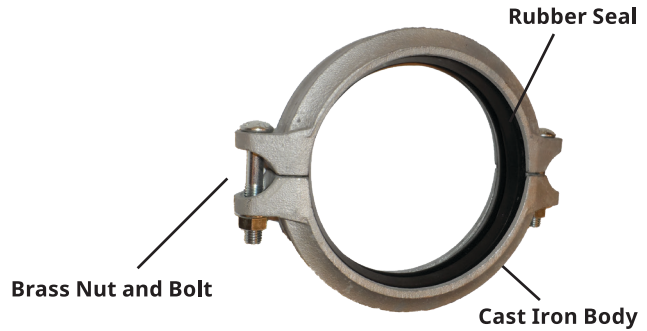

ORDER GUIDE

Part #	CASE QTY	LIST PRICE
RP-GRCP-2GG = 2" Diameter two piece cast iron,grooved, flexible coupling, 300 PSI rating	1	\$14.86
RP-GRCP-3GG = 3" Diameter two piece cast iron,grooved, flexible coupling, 300 PSI rating	1	\$19.86
RP-GRCP-4GG = 4" Diameter two piece cast iron,grooved, flexible coupling, 300 PSI rating	1	\$28.42
RP-GRCP-6GG = 6" Diameter two piece cast iron,grooved, flexible coupling, 300 PSI rating	1	\$49.03
RP-GRCP-8GG = 8" Diameter two piece cast iron,grooved, flexible coupling, 300 PSI rating	1	\$79.32
RP-GRCP-10GG = 10" Diameter two piece cast iron,grooved, flexible coupling, 300 PSI rating	1	\$143.67
RP-GRCP-12GG = 12" Diameter two piece cast iron,grooved, flexible coupling, 300 PSI rating	1	\$196.14

Pressure Gauges



GLYCERIN FILLED

ORDER GUIDE

GLYCERIN FILLED	CASE QTY	LIST PRICE
PG-LG060S = 2 - 1/2" Glycerin filled pressure gauge 0-60 PSI	10	\$23.92
PG-LG100S = 2 - 1/2" Glycerin filled pressure gauge 0-100 PSI	10	\$23.92

12" Sand Media Filters



Part #	Equivalent Mesh Size	Volume of Media per Tank	Recommended Back Wash flow (Minimum)	Recommended Back Wash flow (Maximum)	Recommended max flow rate per tank
#12 SILICA SAND	140	5GAL / .75 CUFT	16 gpm 61 lpm	30 gpm 114 lpm	25 gpm 94 lpm
#16 SILICA SAND	170	5GAL / .75 CUFT	12 gpm 45 lpm	25 gpm 95 lpm	20 gpm 75 lpm
#20 SILICA SAND	230	5GAL / .75 CUFT	9 gpm 34 lpm	15 gpm 57 lpm	16 gpm 60 lpm
#30 SILICA SAND	400	5GAL / .75 CUFT	6 gpm 23 lpm	12 gpm 45 lpm	12 gpm 45 lpm
14x40 MESH ZEOLITE	Down to 5 Microns	5GAL / .75 CUFT	6 gpm 23 lpm	12 gpm 45 lpm	10 gpm 37 lpm

PRESSURE LOSS (PSI) COMPARISON CHART - % GALLONS OF MEDIA APPROX. 6" BELOW TOP

Flow Rate (gpm)	Zeolite	#30 Sand	#20 Sand	#16 Sand	#12 Sand
15	1.5	2	1.5	1.0	1.0
20	2.5*	4*	3.0	2.0	1.5
25	3.5*	5*	4.0*	3.0	2.5

* NOT RECOMMENDED

NOTE:
Refer to Sand Media Brochure for dimension information.

24" Sand Media Filters



Part #	Equivalent Mesh Size	Volume of Media per Tank	Recommended Back Wash flow (Minimum)	Recommended Back Wash flow (Maximum)	Recommended max flow rate per tank
#12 SILICA SAND	140	18GAL / 2.5 CUFT	64 gpm 242 lpm	120 gpm 454 lpm	100 gpm 379 lpm
#16 SILICA SAND	170	18GAL / 2.5 CUFT	48 gpm 182 lpm	100 gpm 379 lpm	80 gpm 303 lpm
#20 SILICA SAND	230	18GAL / 2.5 CUFT	36 gpm 136 lpm	60 gpm 227 lpm	64 gpm 242 lpm
#30 SILICA SAND	400	18GAL / 2.5 CUFT	24 gpm 91 lpm	48 gpm 182 lpm	48 gpm 182 lpm
14x40 MESH ZEOLITE	Down to 5 Microns	18GAL / 2.5 CUFT	24 gpm 91 lpm	48 gpm 182 lpm	48 gpm 182 lpm

PRESSURE LOSS (PSI) COMPARISON CHART - % GALLONS OF MEDIA APPROX. 6" BELOW TOP

Flow Rate (gpm)	Zeolite	#30 Sand	#20 Sand	#16 Sand	#12 Sand
60	1.5	2	1.5	1.0	1.0
80	2.5*	4*	3.0	2.0	1.5
100	4.0*	5.5*	4.5*	3.5	3.0

* NOT RECOMMENDED

NOTE:
Refer to Sand Media Brochure for dimension information.

12" TANK ORDERING INFORMATION

Part #	Description	Inlet / Outlet	Back Flush	Flow (GPM)
WT-2HGA	2 Tank Horizontal	Groove	Automatic	30-50
WT-2HGM	2 Tank Horizontal	Groove	Manual	30-50
WT-2HUA	2 Tank Horizontal	Union	Automatic	30-50
WT-2HUM	2 Tank Horizontal	Union	Manual	30-50
WT-2VUA	2 Tank Vertical	Union	Automatic	30-50
WT-2VUM	2 Tank Vertical	Union	Manual	30-50
WT-3HGA	3 Tank Horizontal	Groove	Automatic	45-75
WT-3HGM	3 Tank Horizontal	Groove	Manual	45-75
WT-3HUA	3 Tank Horizontal	Union	Automatic	45-75
WT-3HUM	3 Tank Horizontal	Union	Manual	45-75
WT-4HGA	4 Tank Horizontal Stacked	Groove	Automatic	60-100
WT-4HGM	4 Tank Horizontal Stacked	Groove	Manual	60-100
WT-4HUA	4 Tank Horizontal Stacked	Union	Automatic	60-100
WT-4HUM	4 Tank Horizontal Stacked	Union	Manual	60-100
WT-5HGA	5 Tank Horizontal Stacked	Groove	Automatic	75-125
WT-5HGM	5 Tank Horizontal Stacked	Groove	Manual	75-125
WT-5HUA	5 Tank Horizontal Stacked	Union	Automatic	75-125
WT-5HUM	5 Tank Horizontal Stacked	Union	Manual	75-125
WT-6HGA	6 Tank Horizontal Stacked	Groove	Automatic	90-150
WT-6HGM	6 Tank Horizontal Stacked	Groove	Manual	90-150
WT-6HUA	6 Tank Horizontal Stacked	Union	Automatic	90-150
WT-6HUM	6 Tank Horizontal Stacked	Union	Manual	90-150

24" TANK ORDERING INFORMATION

Part #	Description	Back Flush	Flow (GPM)
WT-24-2-HGM	2 Tank Horizontal	Manual	80-200
WT-24-2-HGA	2 Tank Horizontal	Automatic	80-200
WT-24-3-HGM	3 Tank Horizontal	Manual	120-300
WT-24-3-HGA	3 Tank Horizontal	Automatic	120-300
WT-24-4-HGM	4 Tank Horizontal Stacked	Manual	160-400
WT-24-4-HGA	4 Tank Horizontal Stacked	Automatic	160-400
WT-24-4Q-HGM	4 Tank Horizontal Quad	Manual	160-400
WT-24-4Q-HGA	4 Tank Horizontal Quad	Automatic	160-400

AUTOMATIC 12" OR 24"

Part #	Description
WTA-150D	Single Station Decoder
WTA-150PD	Back Flush Controller 2-99 Tanks (Includes PDS)

For systems of 5 tanks or more, use any combination of equipment above to meet your flow requirements. Purchase one system that is Automatic and the balance of tanks manual. For each Manual tank, purchase one each WTA-150D decoder to tie all tanks into the Automated system for systems of 5 or more tanks, Don't hesitate to contact factory at 800-468-0071 for pricing and suggested layout options. Above Systems can be combined for higher flow rates. Additional manifolds required.

Superior by Design

An Underdrain Exclusively designed for a Superior Back Flush everytime.

Eliminates Channeling

Saves Back Flush Water

Total Media Cleaning

Full Vertical Flow

Balanced Flow and Distribution



Water Tool Underdrain



Water Tool™ Filters

Media Filters

Lindsay CA, USA. (800) 468-0071 Rainproco.com



Self Cleaning Automatic Gravity Screen Filter

FEATURES

- Low initial cost
- All plastic construction
- Light weight for easy and fast installation
- Lower freight costs
- No rust problems
- No theft problems for scrap metal
- 24VAC drive motors, last longer than 12VDC motors
- Modular construction for higher flow rates
- Manifold units together for higher flow rates
- 20-180 GPM flow rates per unit
- Inexpensive screen replacements
- Different size screen mesh available
- Large dirt and trash collection reservoir
- 4" socket or groove inlet and outlet connections
- Quick change two piece flat spray cleaning nozzles, only two part nozzle
- Multiple drain outlets for each chamber



4" socket or groove outlet / inlet

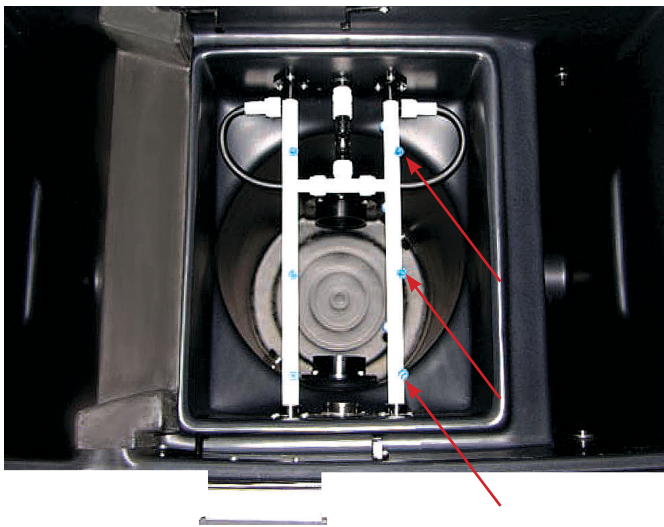

Easy clean nozzles

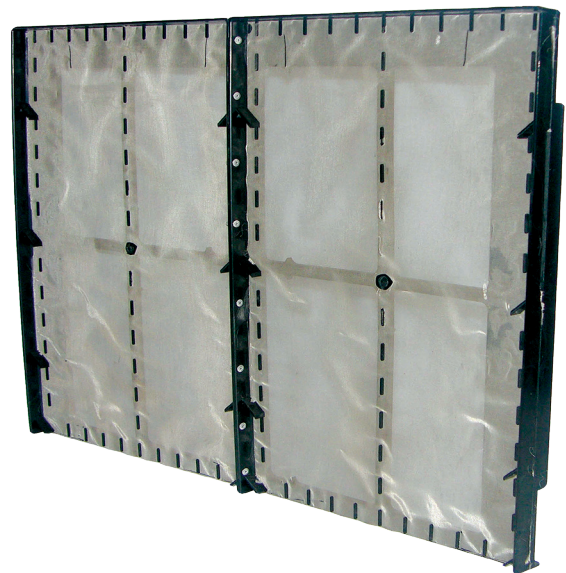

Plastic framed stainless steel mesh screen.

Dual Stage Lake/Pump Filter

The RainPro Lake/Pump Filters are dual staged with both an outer and inner filter designed for use on the intake side of a pump that is typically drawing from a pond or lake. These Lake/Pump Filters are easily matched to the Flow requirements of any application with the unique 2" male spigot connections on each end for easy manifolding using standard 2" slip PVC fittings or Union connections. The PON-006, 6" diameter unit is designed for 0 to 40 gallon per minute flow and the PON-012, 12" diameter unit is designed for 0 to 80 gallons per minute flow. The size and quantity of filters required is dependent on desired flows. The RainPro Lake/Pump Filters are manufactured of Heavy Duty PVC top and bottoms with rigid molded PVC inner and outer filtration walls. The hardware is all Stainless Steel.

The PON-006 has a 6" outer molded filter screen with exactly 38.8 square inches of total open area and an inner 2" molded diameter filter screen with exactly 21.6 square inches of total open area. The PON-006 is rated for 0 to 40 GPM in clean water.

The PON-012 has a 12" outer molded filter screen with exactly 82.0 square inches of total open area and an inner 6" molded diameter filter screen with 38.8 square inches of total open area. The PON-012 is rated for 0 to 80 GPM in clean water.

With the relatively large surface intake area, the velocities remain low, minimizing the suction of unwanted debris from the surrounding area.

OPERATING SPECIFICATIONS

- Each Pon-012 filter added to system equates to an additional 80 GPM capacity. Centerline pipe must be sized to maximum flow desired.
- All connections to filter use standard 2" slip PVC fittings, including; tees, ells, couplings, male or female threaded adapters, unions etc.
- This filter system provides you the most flexibility and cost effective means of assembling the filter design that meets your system requirements.
- Each filter includes 2" slip PVC Schedule 40 threaded female adapter and a 2" slip PVC Schedule 40 cap.

Popular Configuration Of PON-012 Lake/Pump Filters

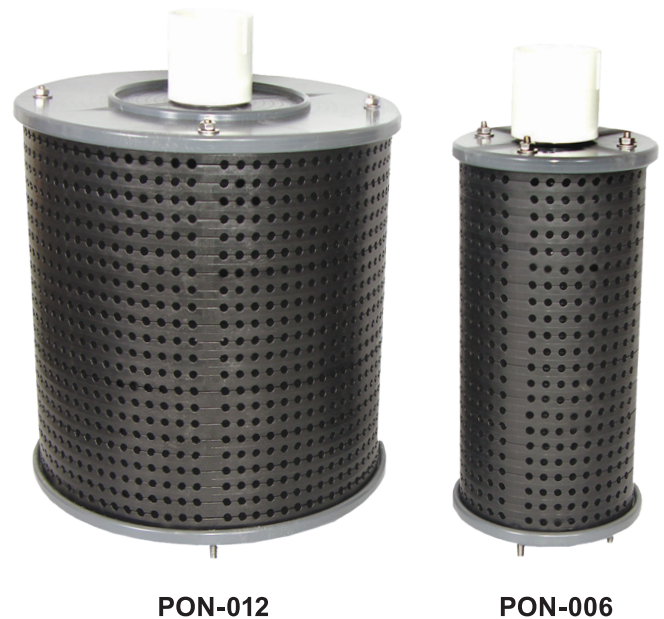
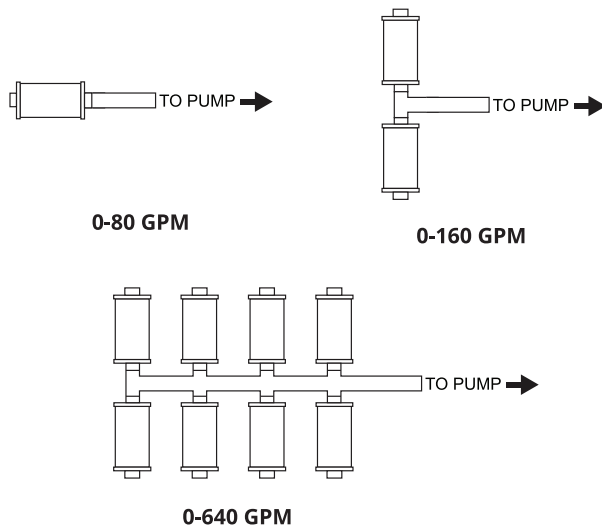

ORDER GUIDE

Part #	Description	Case Qty	List Price
PON-006	6" Lake/Pump Filter, 0-40 GPM, with 2" PVC connection fittings	1	\$289.81
PON-012	12" Lake/Pump Filter, 0-80 GPM, with 2" PVC connection fittings	1	\$336.96

Rainpro Hand Pump

The RainPro hand pump is a manually operated, rugged, self priming, debris tolerant pump that is manufactured to easily and quickly pump out water filled; valve boxes, broken pipe lines, sprinkler repair sites or anyplace you want to pump water away from. This hand pump will flow up to 13 GPM or ¼ gallon per stroke.

To use, simply insert the 1-½” pump intake on bottom of shaft into the water you want vacated and place the flexible outlet hose (6’ long) to the location you want the water to be pumped. The water can be muddy and laden with dirt and debris. Should pump get clogged, it can be easily disassembled, cleaned and back to use in a couple of minutes. Repair parts are available.

FEATURES

- High Flow Capacity – 13 GPM, 4 strokes per gallon
- Self Priming Action
- Debris Tolerant
- Special reinforced shaft
- Intake grate filter designed to prevent internal clogging of any ingested debris
- Removable Intake Cap and Top Cap for easy cleaning
- Outlet Stake directs discharge where you want it to go
- Polyvinyl body and components eliminate Rust or Corrosion
- Made in the USA

OPERATING SPECIFICATIONS

- Body has overall length of 39”, diameter of 1-1/2”
- Flexible outlet hose is 6’ long and will not crush

ORDER GUIDE

PART #	CASE QTY	PRICE LIST
HP-33-G = Pump with 3 foot outlet hose	10	\$83.59
HP-36-G = Pump with 6 foot outlet hose	10	\$107.10

REPLACEMENT PARTS
HP-3EXT = 3 foot hose extension
HP-159 = HP foot check valve assembly

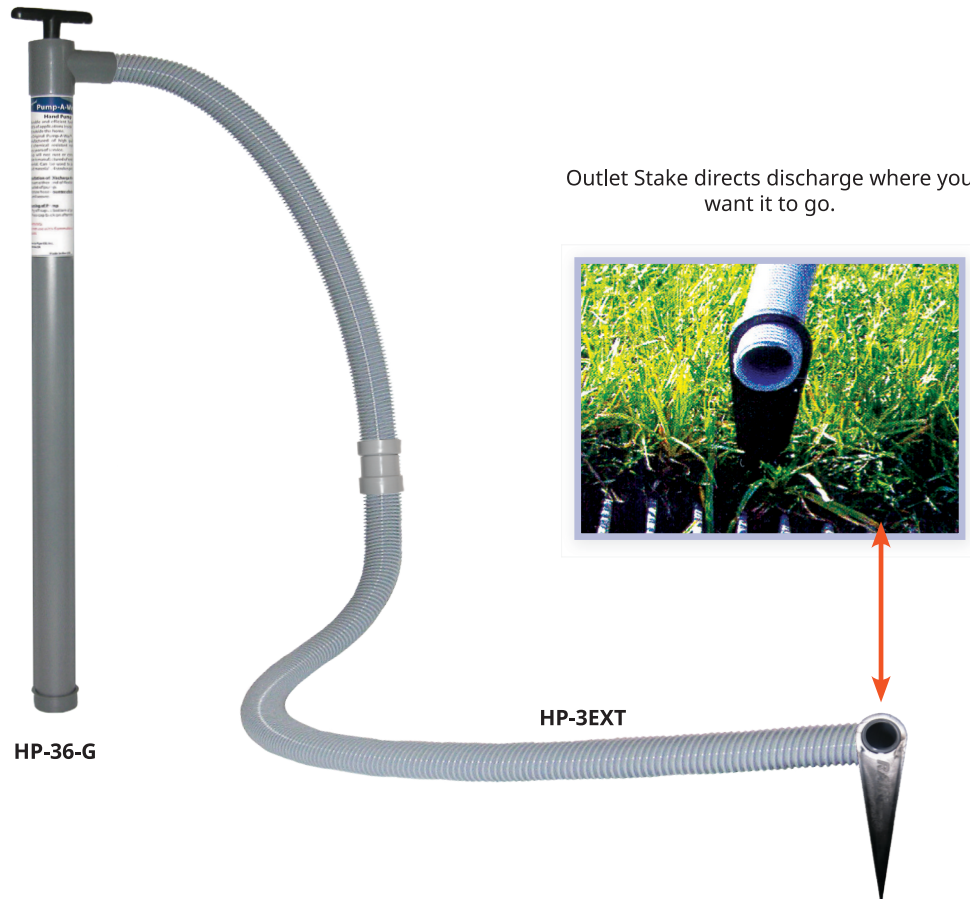



Rain Pro, a division of HIT Products Corporation, is a leader in the irrigation industry. Founded in 1982, HIT Products Corporation has created and manufactured numerous products that have proven beneficial for our customers. "Intelligent Irrigation Solutions" is our slogan that propelled Rain Pro into the new era of water efficiency and distribution. As a manufacturer, HIT is committed to providing our customers with time-tested products and newer, more efficient ones. In addition, HIT applies sustainability practices to our development so that you, the customer, know that our products will meet your standards. As a result, technologically advanced efficiencies have shown cost savings in installation and maintenance in irrigation systems. Thank you for your business and continued support! We look forward to working with you.

Sales Policy - RainPro Products are sold through recognized Professional Wholesale Irrigation Distributors only.

Minimum Order - \$250 net, case/bag quantities only. No broken case or bag quantities.

Claim for Shortage - All claims for shortage are to be made in writing to: RainPro, P.O. Box 929, 556 South Mirage Avenue Lindsay, CA. 93247 USA or FAX (559) 562-6626 within 15 days of receipt of goods.

Returned Merchandise - Restocking / Inspection Fee of 25% will be assessed. No returned merchandise will be accepted without prior approval and a Returned Goods Authorization number issued by factory. RGA number must be prominently displayed on the outside of the shipping carton. All shipments must be freight prepaid. All returned merchandise is for replacement only. To obtain a RGA number, please call (559) 562-5975 Extension 109.

List Price - All prices are shown in U.S.A. dollars and are subject to change without prior notice.

"Glue-N-Go" Manifolds

Installation - All manifolds are recommended to be installed at ground level. In addition, tubing attached to manifolds should never be anchored, thus allowing for expansion and contraction of the tubing without adding stress to the manifold.

Warranty - HIT Products will repair or replace, at their discretion, without charge, all parts which are found to have original defects within the warranty period, provided the product is returned at the customer's expense. From the initial sale date, the warranty period is two years. Warranty will be void on all parts if the tubing is anchored in the field, not to allow for shrinkage and expansion.



Find more Price Lists here at hitproductscorp.com